

IMPORTANT NOTE:

Read this manual carefully before installing or operating your new heat pump.
Make sure to save this manual for future reference.

Contents

| | |
|---|----|
| PART 1 GENERAL INFORMATION..... | 2 |
| 1. MEASUREMENTS..... | 2 |
| 2. EXTERNAL APPEARANCE..... | 2 |
| 3. NOMENCLATURE | 2 |
| PART 2 PERFORMANCE | 3 |
| 1. FEATURES | 3 |
| 2. REFRIGERANT CIRCUIT | 4 |
| 3. UNIT STRUCTURE | 5 |
| 4. SPECIFICATIONS..... | 6 |
| 5. DIMENSION (UNIT: MM)..... | 9 |
| 6. PERFORMANCE DIAGRAM | 10 |
| 7. WIRING DIAGRAM | 16 |
| 8. INSTALLATION..... | 18 |
| 9. USE..... | 28 |
| 9.1 CHECKING LIST BEFORE TRIAL- RUNNING: | 28 |
| 9.2. INITIAL STARTUP..... | 28 |
| 10. MAINTENANCE | 30 |
| 11. TROUBLE SHOOTING..... | 32 |
| 12. FUNCTION..... | 45 |
| 13. OPERATION..... | 49 |
| 14. ACCESSORIES..... | 56 |
| 15. RESISTANCE CHARACTERISTIC OF TEMPERATURE SENSOR | 57 |

Part 1 General information

1. Measurements

| Model | Net/Gross weight (kg) | Dimension (mm, WxDxH) | Power Supply |
|----------|-----------------------|-----------------------|----------------------|
| SWH-190P | 91/112 | 595x560x1730 | 220-240V~, 50Hz, 1Ph |
| SWH-300P | 123/148 | 695x660x1895 | |

2. External appearance



SWH-190P

SWH-300P

3. Nomenclature

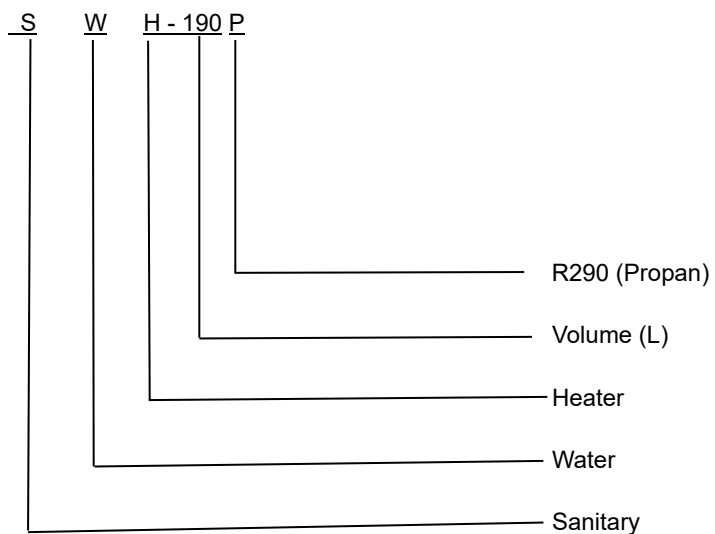

Part 2 Performance

1. Features

- ◇ Microchannel heat transfer technology
 1. Design of multi-loop flat channels reduce condensation pressure
 2. Enhanced surface with parallel flow design effectively increases heat transfer efficiency
 3. High-strength design, endured 9 MPa pressure
 4. High performance heat-conductive paste significantly improves heat transfer efficiency



- ◇ The maximum outlet water temperature: 70°C. The system makes the water be heated stably and quickly with innovative heating methods of combination the electric heating and heat pump heating properly.
- ◇ Automatic startup and shutdown, automatic defrosting by revising refrigerant cycle to save the extra operation.
- ◇ According to the heat pump principle, the unit absorbs heat from outdoor air and produce heat water; thermal efficiency can be up to 3.25(Under the condition 16147).
- ◇ CE, LVD, RED, keymark, ERP& NF certification.
- ◇ Within the temperature range from -20 °C to 46 °C, the unit will not be affected by night, cloudy sky, rain even snow weather.

2. Refrigerant circuit

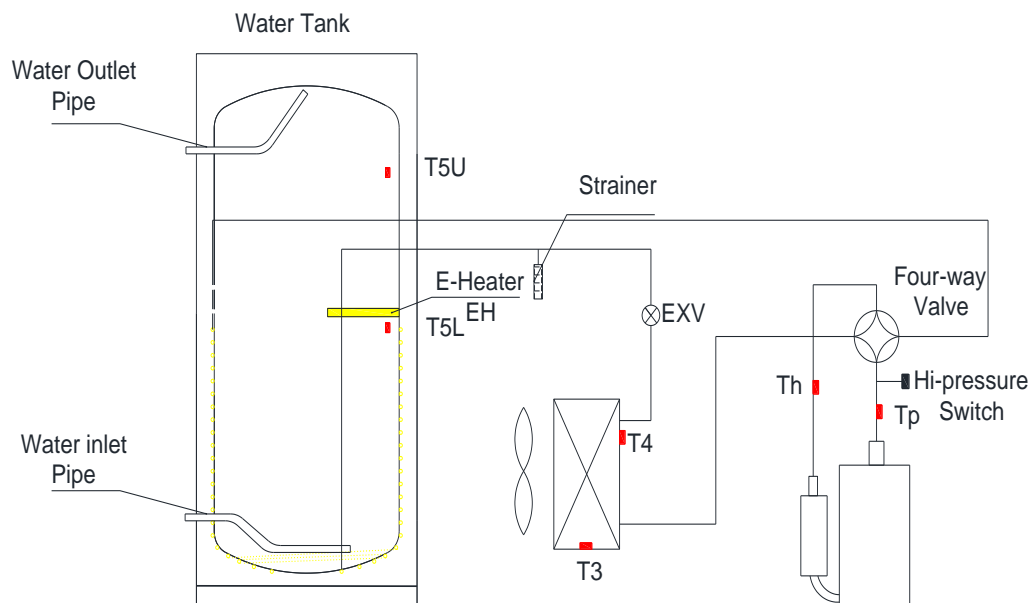

Compressor: RDSN89V11TZL(190L) & RDSN108V11TBZ(300L), R290 high efficiency compressor, supplied by GMCC.

Evaporator: copper tube and aluminum fin type heat exchanger.

EXV: electronic expansion valve, the opening is regulated according to the discharge air temperature of compressor.

Fan: centrifugal fan. The motor is supplied by Welling or Green-Intelligence.

TCO (Temperature Switch): The power of compressor and E-heater will be automatically shut-of or turn on by TCO. If the water temperature is higher than 85°C, the TCO will automatically shut of the power of compressor and E-heater. After that it needs to be reset manually.

3. Unit structure

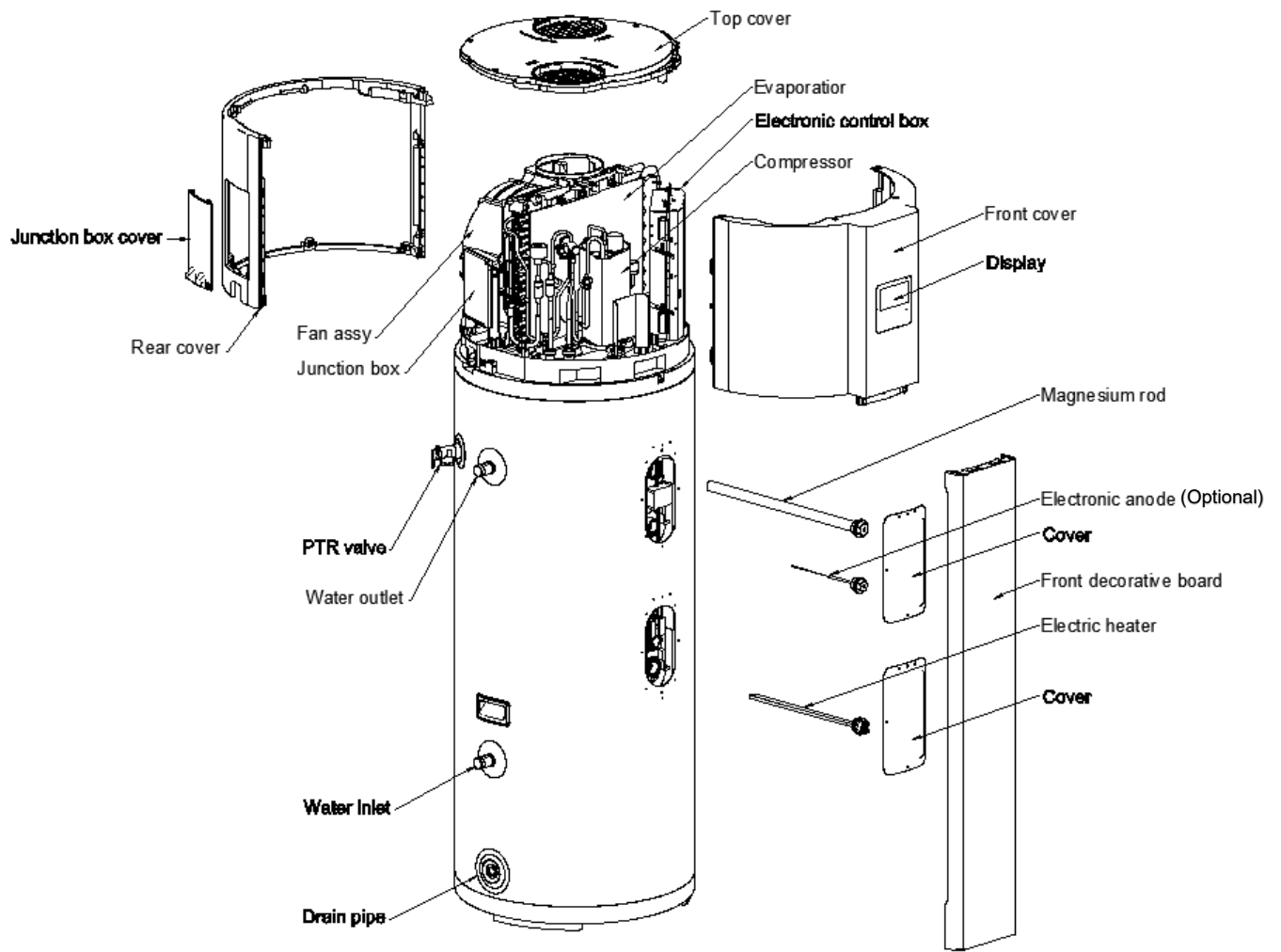

4. Specifications

| Model | | | SWH-190P | SWH-300P |
|---|---|-------------|----------------|----------------|
| Power supply | | Ph-V- Hz | 1-220~240-50 | 1-220~240-50 |
| Running ambient temp. | Heat pump | °C | -7~43 | -7~43 |
| | E-heater | | -20~46 | -20~46 |
| Storage size | | Ltr | 185 | 275 |
| Maximum inlet water pressure | | Mpa | 0.7 | 0.7 |
| Net/gross weight | | kg | 91/112 | 123/148 |
| Dimension (D×H) | | mm | 560×595×1730 | 660×695×1895 |
| Packing (W×D×H) | | mm | 655×675×1945 | 775×745×2110 |
| MAX.Hot water temperature with heat pump | | °C | 65 | 65 |
| MAX.Hot water temperature additional electric heater | | °C | 70 | 70 |
| Tank | Material | - | Enameled steel | Enameled steel |
| | Cathodic protection | - | Mg rod anode | Mg rod anode |
| | Insulating type | - | Polyurethane | Polyurethane |
| | Insulation thickness | mm | 42 | 46 |
| | Water inlet pipe | mm | DN20 | DN20 |
| | Water outlet pipe | mm | DN20 | DN20 |
| | Drainage pipe | mm | DN20 | DN20 |
| | Max. operating pressure(safety valve) | MPa | 0.85 | 0.85 |
| Electrical data (Heat pump+ electric heater) | Maximum heat pump power input | W | 600 | 710 |
| | E-heater | W | 1640 | 1640 |
| | Maximum power input | W | 2240 | 2350 |
| | Maximum current input | A | 10.5 | 11.0 |
| Refrigerant design pressure | | MPa | 2.7/1.1 | 2.7/1.1 |
| Air circuit | Fan type | - | Centrifugal | Centrifugal |
| | Ari volume flow rate | m³/h | 350 | 450 |
| | Rated external static max pressure | Pa | / | 30 |
| | Available external static max pressure (Modified via engineering mode) | Pa | 20 | 80 |
| | Ducts diameter | mm | 160 | 190 |
| Refrigerant circuit | Compressor | - | Rotary | Rotary |
| | Refrigerant | - | R290 | R290 |
| | Refrigerant charge | g | 150 | 150 |

| | | | | |
|---|---|-------------------|--|--|
| | Evaporator | - | Copper-aluminum finned coil | Copper-aluminum finned coil |
| | Condenser | - | Aluminum tube wound outside tank | Aluminum tube wound outside tank |
| Solar coil | Material | - | / | / |
| | Surface | m ² | / | / |
| | Max pressure | MPa | / | / |
| Data according to EN 16147: 2017 standard for AVERAGE climate (unit in ECO mode, Hot water setpoint = 54 ° C; Inlet water = 10 ° C; Inlet air temp = 7 ° C DB / 6 ° C WB) * according to European regulation 812/2013 | Load profile | - | L | XL |
| | Water heating energy efficiency class | - | A+ | A+ |
| | Water heating energy efficiency - η | % | 131.1 | 132 |
| | COP _{DHW} | - | 3.146 | 3.25 |
| | Maximum volume of mixed water at 40°C-V ₄₀ | L | 245 | 350 |
| | Reference hot water temperature- θ_{wh} | °C | 53 | 52 |
| | RaTBD heat output -PraTBD | kWh | 11.694 | 19.07 |
| | Heating up time-t _h | hh:m m | 7:32 | 8:58 |
| | Annual electricity consumption-AEC | kWh/a | 780.8 | 1267 |
| | Stand-by power input(P _{es}) | W | 27 | 19.1 |
| SCF (Smart) | % | 13 | / | |
| Data according to EN 12102-2: 2019 ECO mode with Inlet air temp = 7 ° C DB / 6 ° C WB | Indoor sound power level (without duct) | dB(A) | 56 | 54 |
| Loading Quantity | 20'/40'/40H | Pcs | 24/54/54 | 21/45/45 |
| Throttling type | | | Electric expansion valve | Electric expansion valve |
| System protection | | | TCO, safety valve, automatic defrosting, over-load protector, etc. | TCO, safety valve, automatic defrosting, over-load protector, etc. |
| Air flow | | m ³ /h | 350 | 450 |
| Compressor | Model | | RDSN89V11TZL | RDSN108V11TBZ |
| | Type | | Rotary | Rotary |
| | Brand | | GMCC | GMCC |
| | Capacity | W | 1710 | 2150 |
| | Input | W | 415 | 518 |

| | | | | |
|-----------------|-----------------------------|-------|-----------------------------------|-----------------------------------|
| | RaTBD current(RLA) | A | 1.88 | 2.42 |
| | Locked rotor Amp(LRA) | A | 10 | 14 |
| | Thermal protector | / | URP-267-XX HPA-315 | URP-267-78 HPA-315 |
| | Capacitor | / | 15 μ F/450V | 20 μ F/450V |
| | Refrigerant oil | ml | XS-601C1 / 140ml | PAG VG60 / 170ml |
| Evaporator coil | Number of rows | / | 2 | 2 |
| | Tube pitch(a)x row pitch(b) | mm | 18 \times 17.3 | 18 \times 17.3 |
| | Fin spacing | mm | 1.3 | 1.3 |
| | Fin type (code) | / | Hydrophilic aluminum | Hydrophilic aluminum |
| | Tube outside dia. and type | mm | Φ 5 Inner groove copper tube | Φ 5 Inner groove copper tube |
| | Coil length x height | mm | 375 \times 324 | 480 \times 324 |
| | Number of circuits | / | 2 | 2 |
| Fan motor | Model | / | ZKFP-34-10-1(DC) | ZKFP-34-10-1(DC) |
| | Brand | / | welling/Green Intelligence | welling/ Green Intelligence |
| | Input | w | 30 | 30 |
| | Speed | r/min | 650 | 650 |

Notes:

1. The test conditions: outdoor temperature 15/12 $^{\circ}$ C (DB/WB), inlet water temperature 15 $^{\circ}$ C, outlet water temperature 45 $^{\circ}$ C.
2. The specification may be changed for product improvement, please refer to the nameplate.

5. Dimension (Unit: mm)

| Connector | spec. |
|------------------|---------|
| hot water outlet | R3/4" |
| cold water inlet | R3/4" |
| PTR valve | RC3/4" |
| drain pipe | NPT3/4" |

SWH-190P

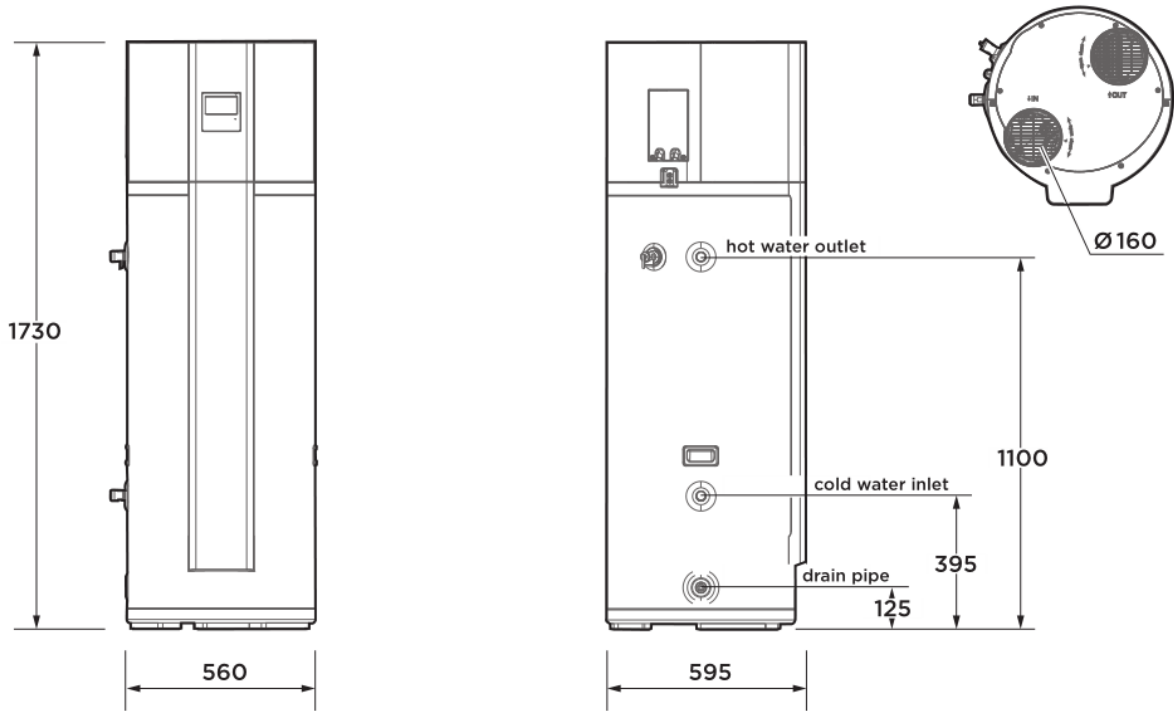

SWH-300P

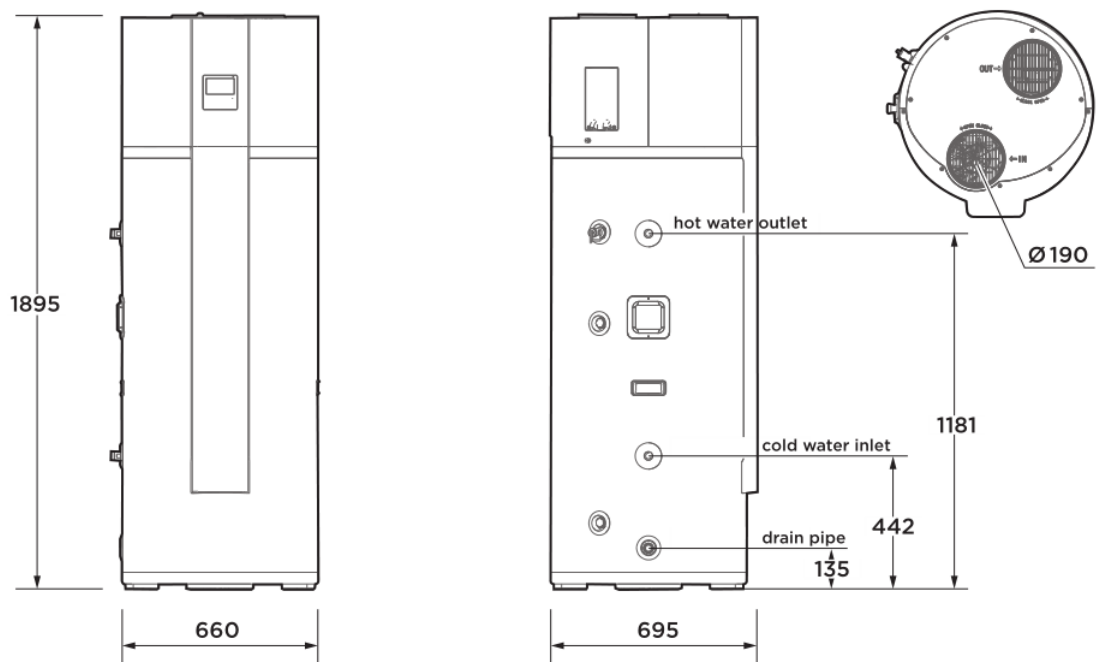

6. Performance diagram

Heat source will be automatically selected by unit. But manually E-Heater operation is available.

Operation range

Setting water temperature target range: 38~70°C.

| | | |
|--|-----------|-------|
| Min. temperature of room of installation | | 0°C |
| Max. temperature of room of installation | | 43°C |
| Minimum air inlet temperature(a) | Heat pump | -7°C |
| | E-heater | -20°C |
| Maximum air inlet temperature(a) | Heat pump | 43°C |
| | E-heater | 46°C |

Water temperature limits

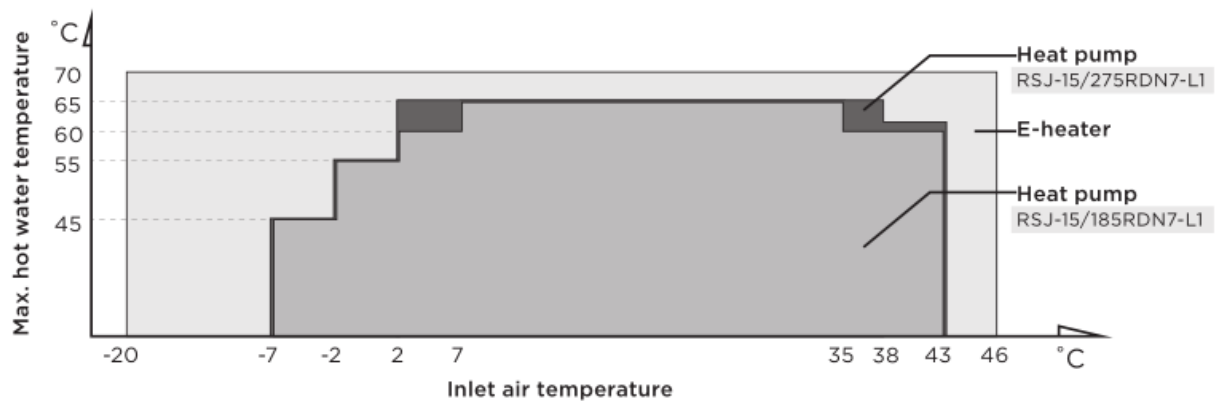

Heat-up Time

There are different heat-up times in different ambient temperature. Lower inlet air temperature result longer heat-up time because of lower effective performance.

When air temp below 2°C, heat pump and E-heater will take different portions of heating capacity, generally the lower of inlet air temperature, the lower portion of heat pump will be taken as well as the higher portion of E-heater will account for.

SWH-190P

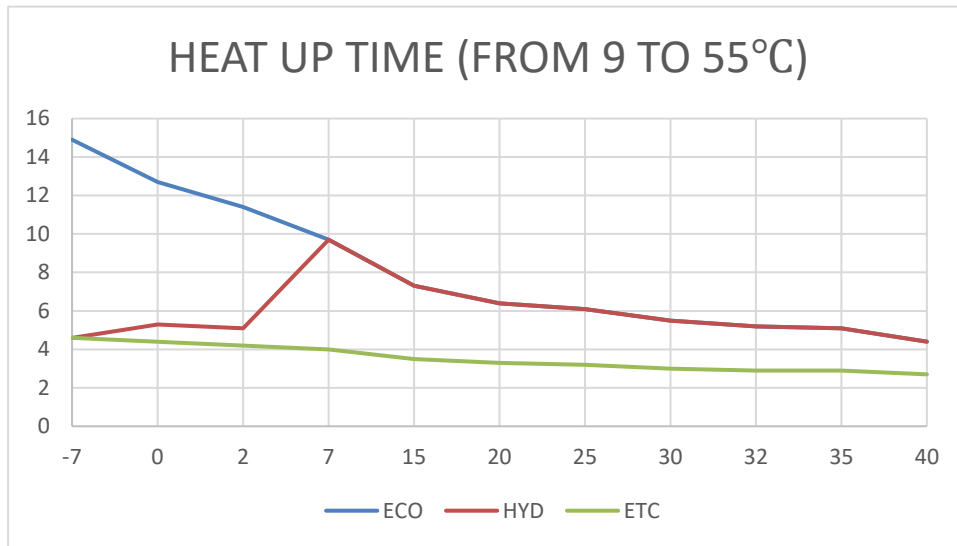

(The test conditions: inlet water at 9 °C, and setting temperature at 55 °C)

| T4 | -7 | 0 | 2 | 7 | 15 | 20 | 25 | 30 | 32 | 35 | 40 |
|-----|------|------|------|-----|-----|-----|-----|-----|-----|-----|-----|
| ECO | 14.9 | 12.7 | 11.4 | 9.7 | 7.3 | 6.4 | 6.1 | 5.5 | 5.2 | 5.1 | 4.4 |
| HYD | 4.6 | 5.3 | 5.1 | 9.7 | 7.3 | 6.4 | 6.1 | 5.5 | 5.2 | 5.1 | 4.4 |
| ETC | 4.6 | 4.4 | 4.2 | 4.0 | 3.5 | 3.3 | 3.2 | 3.0 | 2.9 | 2.9 | 2.7 |

The curve between heat up time and ambient temperature

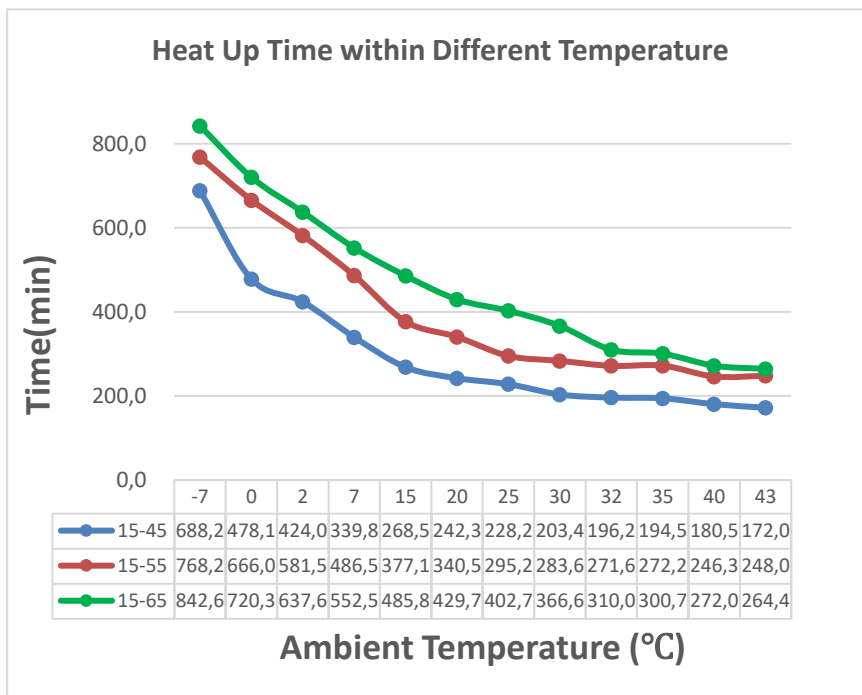

The curve between capacity and ambient temperature

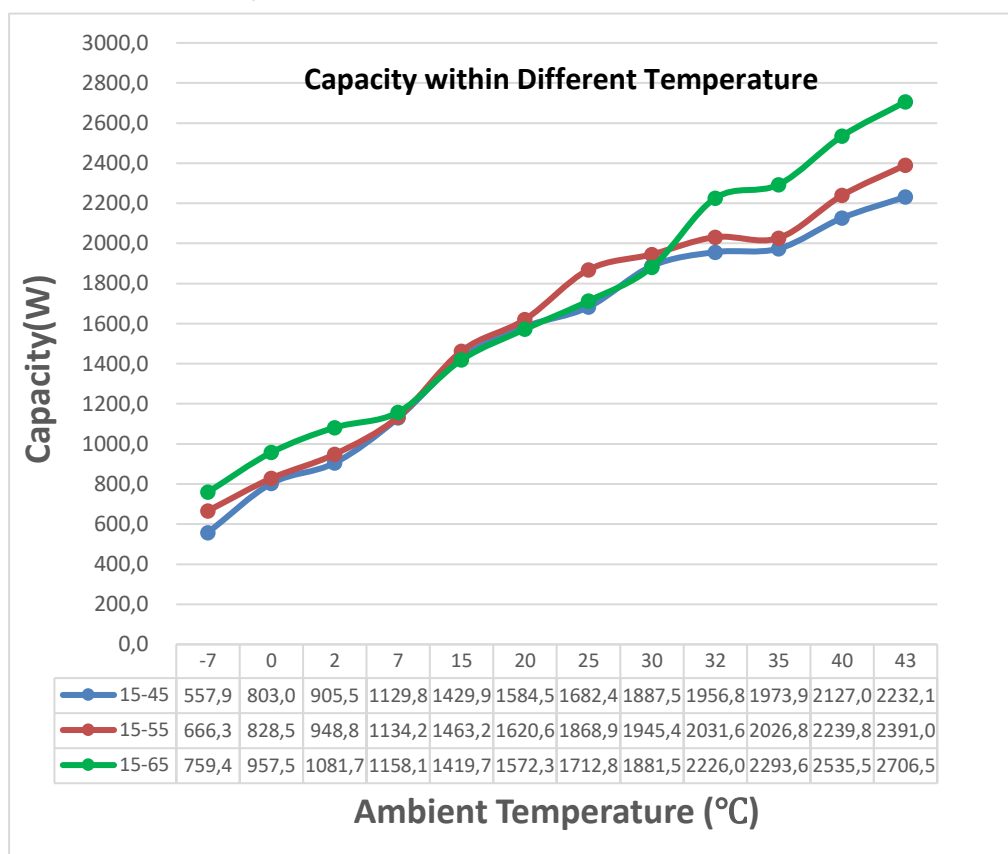

The curve between COP and ambient temperature

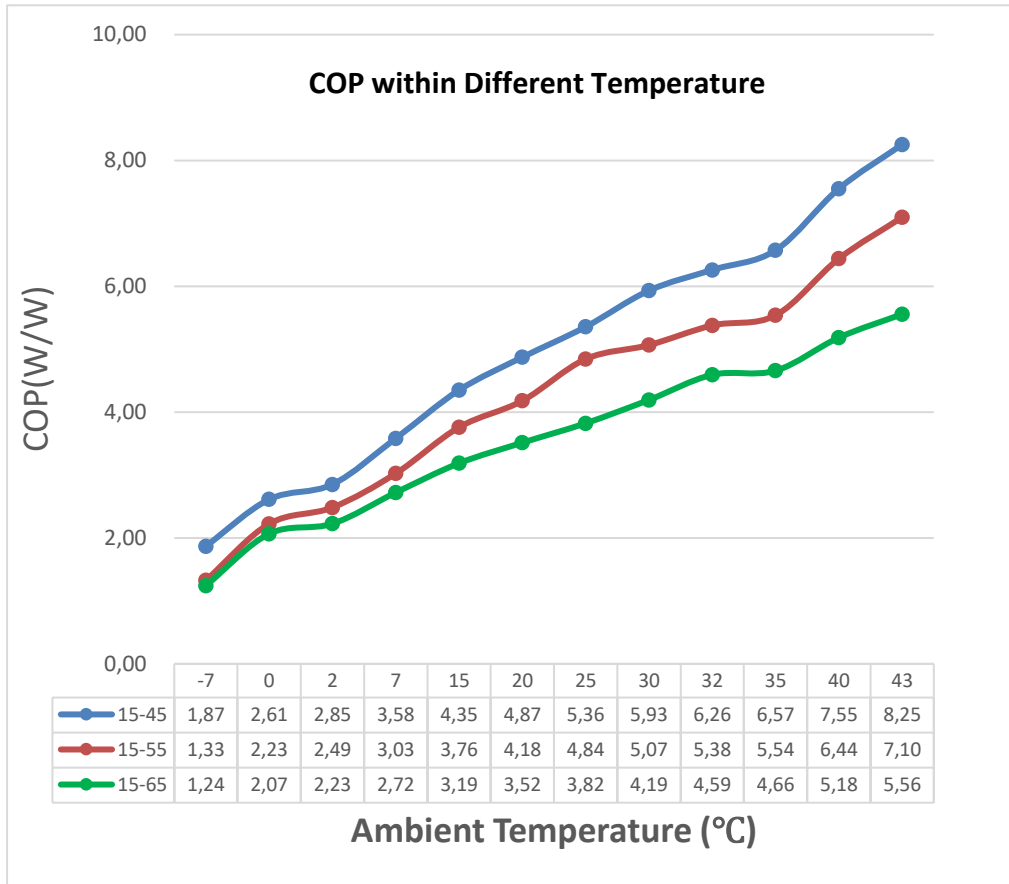

SWH-300P

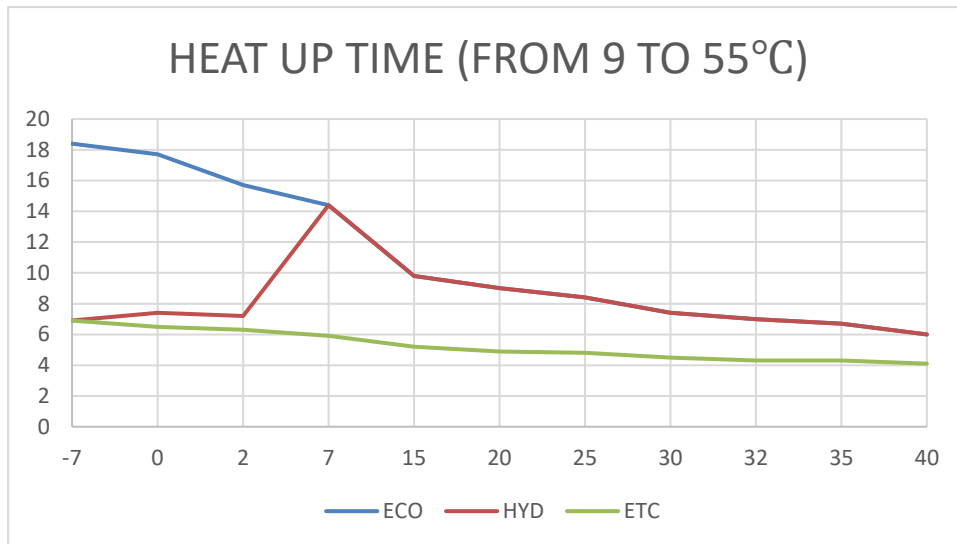

(The test conditions: inlet water at 9 °C, and setting temperature at 55 °C)

| T4 | -7 | 0 | 2 | 7 | 15 | 20 | 25 | 30 | 32 | 35 | 40 |
|-----|------|------|------|------|-----|-----|-----|-----|-----|-----|-----|
| ECO | 18.4 | 17.7 | 15.7 | 14.4 | 9.8 | 9 | 8.4 | 7.4 | 7 | 6.7 | 6 |
| HYD | 6.9 | 7.4 | 7.2 | 14.4 | 9.8 | 9 | 8.4 | 7.4 | 7 | 6.7 | 6 |
| ETC | 6.9 | 6.5 | 6.3 | 5.9 | 5.2 | 4.9 | 4.8 | 4.5 | 4.3 | 4.3 | 4.1 |

The curve between heat up time and ambient temperature

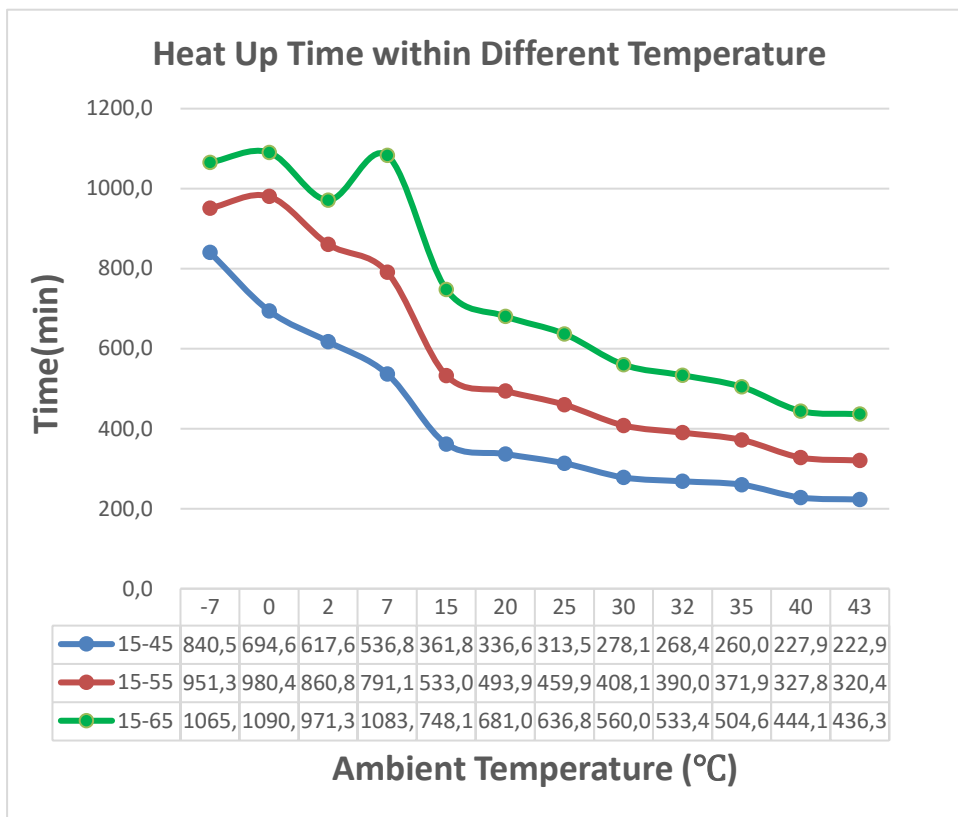

The curve between capacity and ambient temperature

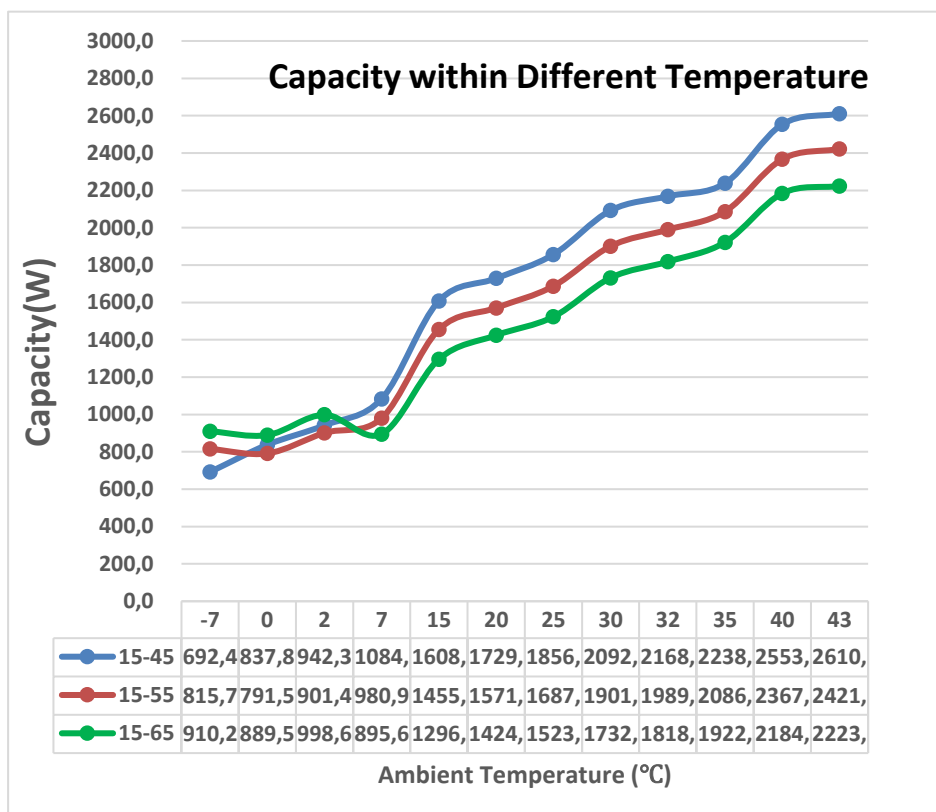

The curve between COP and ambient temperature

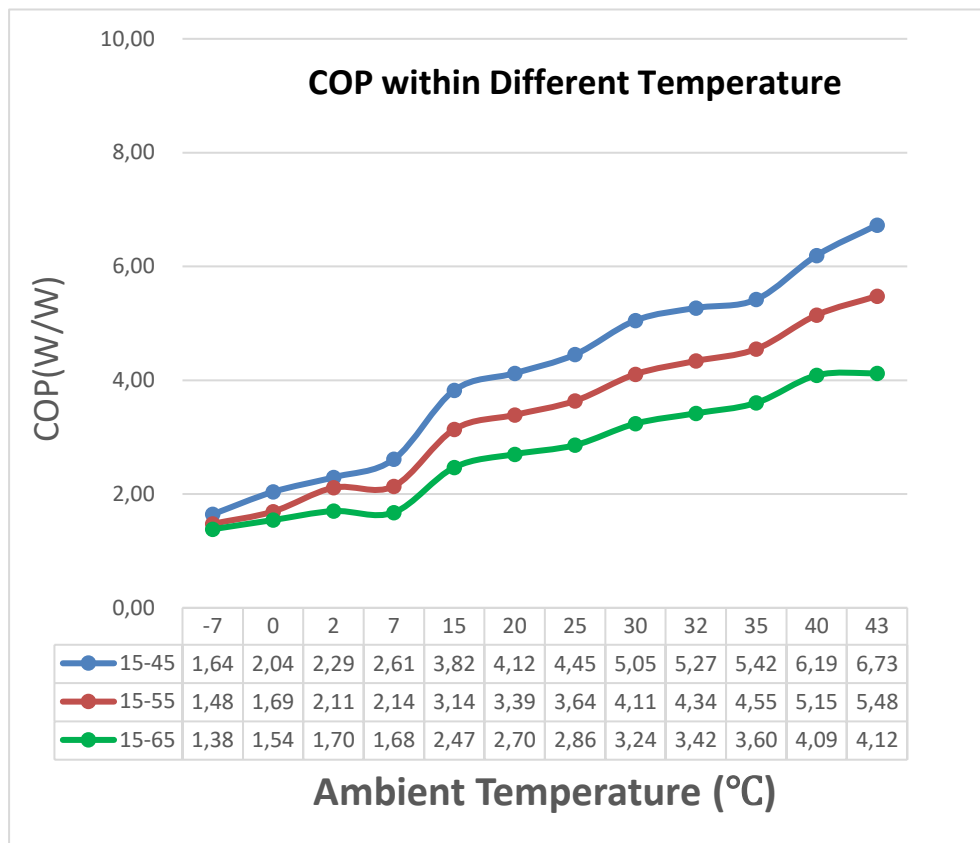

7. Wiring diagram

| CODE | NAME |
|-------|-----------------------------------|
| CT1 | CURRENT TRANSFORMER |
| CT2 | ZERO SEQUENCE CURRENT TRANSFORMER |
| T3 | EVAPORATOR TEMPERATURE SENSOR |
| T4 | AMBIENT TEMPERATURE SENSOR |
| T5U | TANK TEMPERATURE SENSOR(UPPER) |
| T5L | TANK TEMPERATURE SENSOR(LOWER) |
| TP | DISCHARGE TEMPERATURE SENSOR |
| TH | SUCTION TEMPERATURE SENSOR |
| EEV | ELECTRIC EXPANSIVE VALUE |
| XT1-3 | MID TERMINAL BASE |
| T5M | SOLAR TEMPERATURE SENSOR |
| E-Mg | ELECTRONIC MAGNESIUM ROD |

| SMART GRID | | |
|----------------------------|---------|---------|
| Operating behavior | EVU/PV | SG |
| Normal operation(Default) | Invalid | Valid |
| Increased operation output | Valid | Invalid |
| Decreased operation output | Invalid | Invalid |

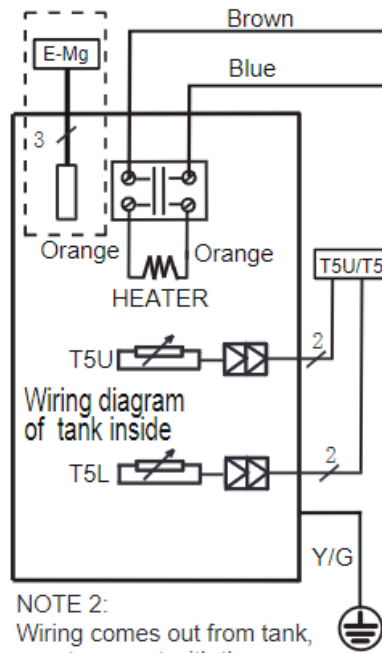

NOTE 2:
Wiring comes out from tank, must connect with the corresponding component.

NOTE 3: P-RS485A; Q-RS485B; E-RS485 GND; X1-Remote ON/OFF Signal; X2-Remote ON/OFF GND

16025300009025 NOTE 1:

This symbol indicates the element is optional, the actual shape shall prevail

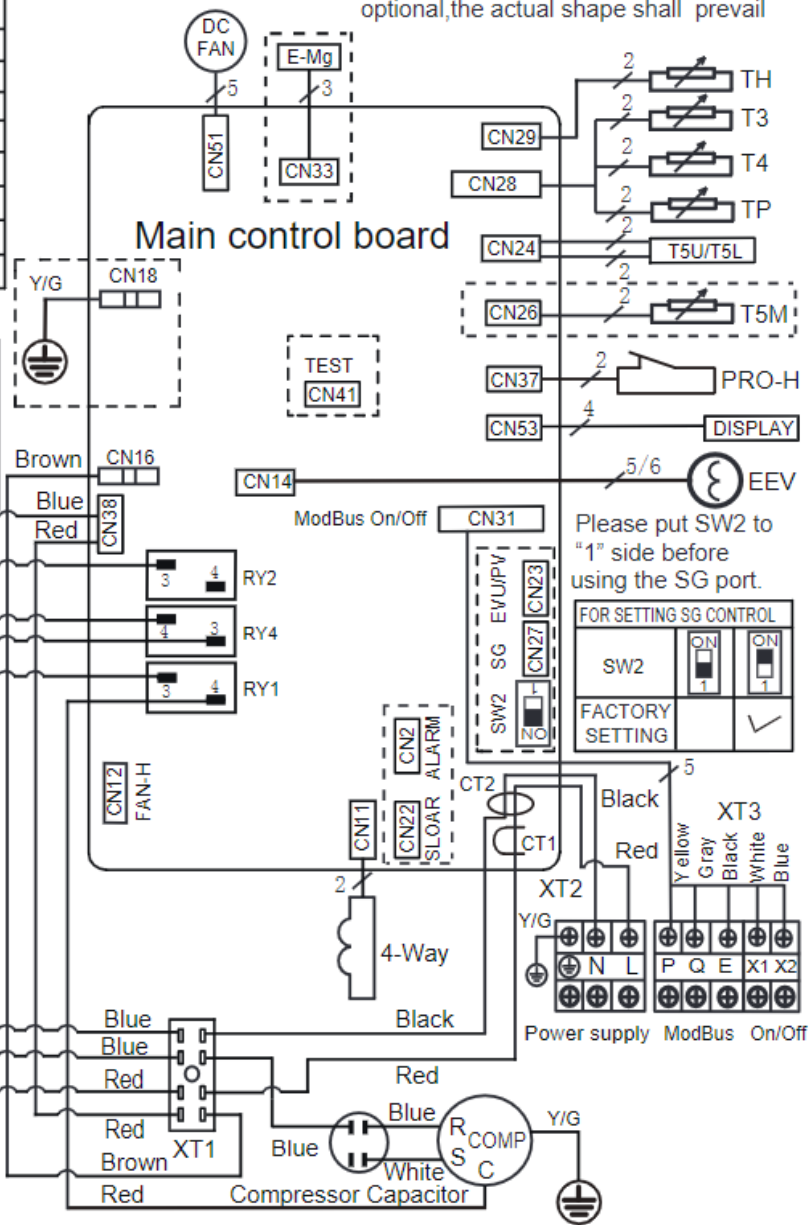

Smart Grid and EVU function:

Smart Grid: The device has a reserved connection port on the main control PCB, to realize this function it is necessary to connect a third-party smart grid switch externally. There is a dip switch next to the SG port, factory setting SW2 = ON (conduct electricity from the grid directly), it is required to manually dial the dip switch to 1 (disconnect) before connecting an external smart grid switch, after which the smart grid icon will light up on the display when the system gets electricity from the grid.

EVU: The device has a reserved EVU port on the main control PCB, it can be connected to photovoltaic input (energy manager) that supports water heater control. The EVU icon will light up on the display

when the system gets photovoltaic input.

Function control logic:

EVU=0 refers to no free photovoltaic power, EVU=1 refers to free photovoltaic power

SG=0 refers to high price electricity, SG=1 refers to low price electricity

1. When EVU=0 and SG=1, the unit operates normally
2. When EVU=1, SG=1 or 0, there is free photovoltaic power, and the system will automatically raise the set temperature to the max set temperature and store hot water, which can achieve the purpose of energy saving
3. When EVU=0 and SG=0, the unit is forced to stop running: (disinfection operation can work after entering the disinfection time)

8. Installation

8.1 Transport

Please carry the unit according to the factory state, do not disassemble it by yourself.

This unit is heavy, it need to be carried by two or more people, otherwise might cause injury and damage.

No contact of fingers and other things with the vanes.

In order to avoid scratch or deformation of the unit surface, put a guard on the surface in contact with hard objects.

While moving, use the handles on both sides of the unit.

Keep it vertical when installing.

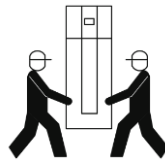

8.2 Location requirements

IMPORTANT! The unit must be installed indoor, it is not allowed to be installed outdoor without shelter. Avoid installation in direct sunlight.

WARNING:

- In case of rain entering to internal components of the unit, the component might be damaged or causing physical danger.
- In terms of the unit connect with duct reaching to outdoor, a reliable water resistant measure must be conduct on the duct, to prevent water from dropping into internal of the unit.
- The unit needs to be securely fixed, otherwise it may cause heavy consequences.

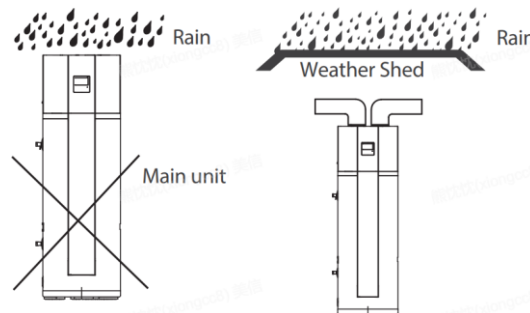

- Enough space for installation and maintenance shall be preserved.
- The ground surface should be flat, and inclined no more than 2°.
- The ground must able to bear the weight of the unit and suitable for installing the unit without increasing noise or vibration.
- To smoothly drain condensate water from the unit, please install the unit at a horizontal floor. Otherwise, ensure the drain vent is at the lowest level.
- The air inlet and outlet should be free from obstacles and strong wind.
- The operation noise and air flow expelled shall not affect neighbors.
- No obstacle around the unit.
- No flammable gas is leaked nearby.

- It is convenient for piping and wiring.
- The ambient air temperature must also be considered when installing this unit, in heat pump mode the air inlet temperature must be above -7 °C and below 43°C. If the inlet air temperature falls outside these upper and lower limits, the electrical elements will be activated to meet the hot water demand and the heat pump does not operate.

CAUTION:

- If the unit is installed on the balcony, the water full weight should not exceed the load-bearing limit of the balcony.
- If the unit has to be installed on a metal part of building, make sure the well electric insulation which should meet the relevant local electric standard.
- The unit installed in indoor space might cause indoor temperature decrease and noise. Please take preventive measures for this.
- The unit should be located in an area not subject to freezing temperatures. The unit located in unconditioned spaces(i.e., garages, basements, etc.) may require the water piping, condensate piping, and drain piping to be insulated to shelter against freezing.
- Installing the unit in any of the following places may lead to malfunction (If it is inevitable, consult the supplier).

-The site contains mineral oils such as lubricant of cutting machines.

-Seaside where the air contains much salt.

-Hot spring area where corrosive gases exist, e.g., sulfide gas.

-Factories where the power voltage fluctuates seriously.

-Inside a car or cabin.

-The place with direct sunlight and other heat supplies. If there's no way to avoid these, please install a covering.

-Place like kitchen where oil permeates.

-Place where strong electromagnetic waves exist.

-Place where flammable gases or materials exist.

-Place where acid or alkali gases evaporate.

-Other special environments.

8.3 Maintenance space (Unit: mm)

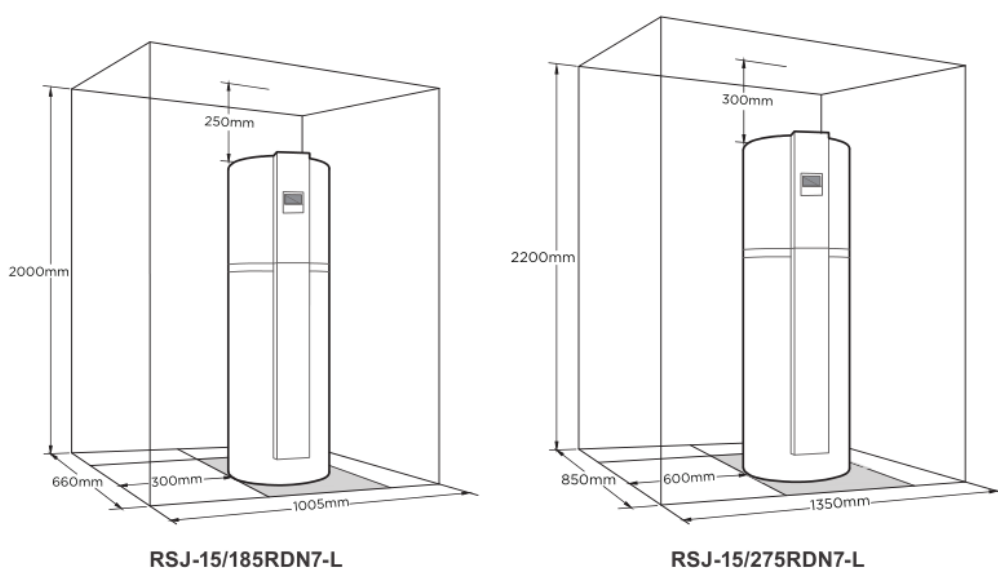

8.4 Fixing method

After finishing all the installation procedures, fix the unit to prevent accidental toppling.

Water heater fixing steps are as follows:

- 1 Take off the front decorative board.
- 2 Install the expansion bolts (not provided) in the wall according to the drawing.
- 3 Fix the end with less holes for mounting the fixing strip on the expansion bolt.
- 4 Tighten the fixing strip and fix the other end to the second expansion bolt through appropriate hole.
- 5 Check whether the water tank is safely and securely fixed. If there's extra fixing strip, please cut off.
- 6 Put back the decorative board.

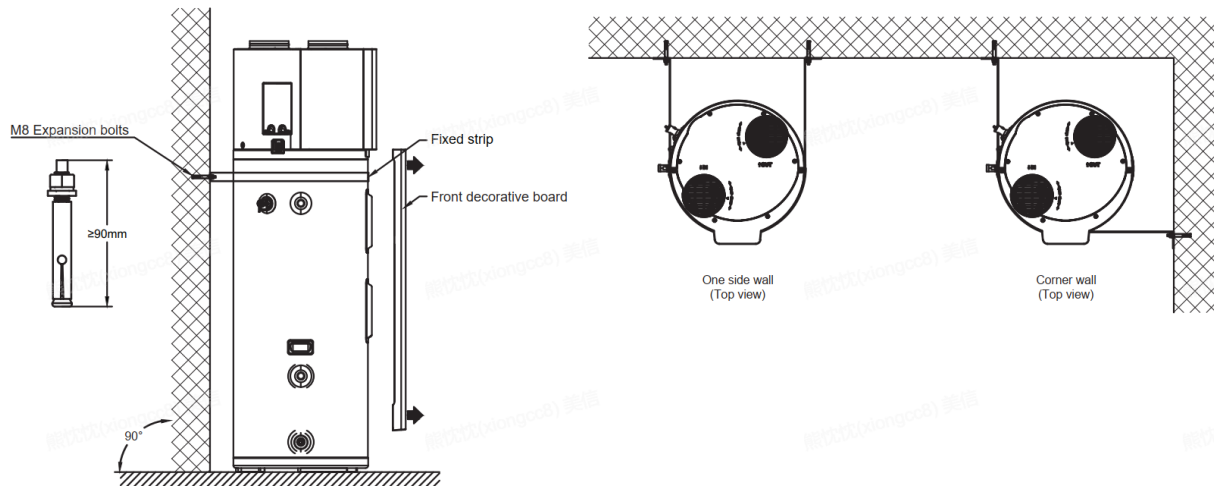

CAUTION:

The appearance and installation orientation of the unit shown above are for reference only and can be adjusted according to the actual installation.

The position of the fixed strip can be adjusted according to the actual situation, make sure the unit is safely and securely fixed.

The expansion bolt requirement must match the weight of the product (loaded with water).

8.5 Water system piping (Hydraulic connection)

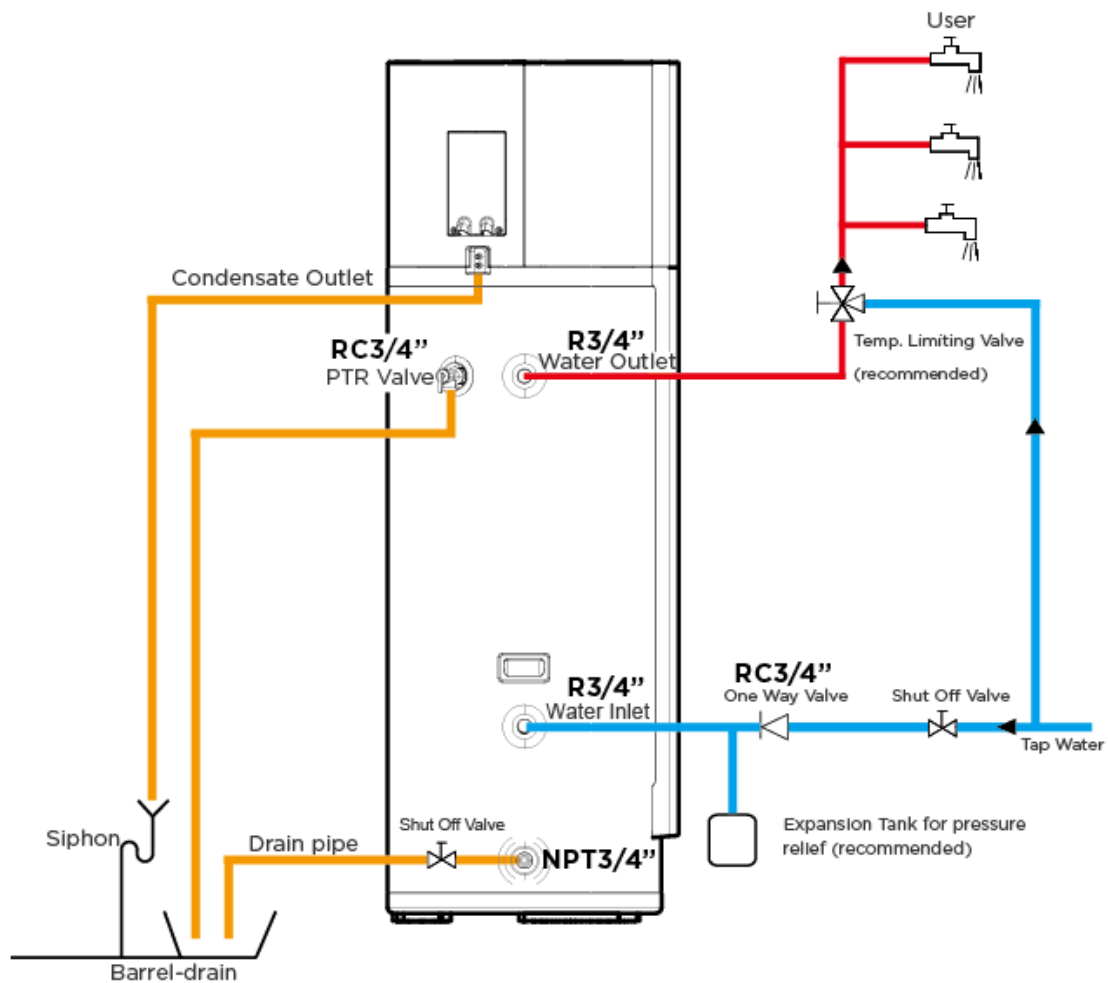

Connect water pipes as the above figure.

Water temperature limiting valve is recommended for mixing the inlet cold water with outlet hot water to prevent burns caused by hot water.

Check before connection, make sure the pipe is clean and free of any foreign matter.

1) Cold water connection

The spec of the water inlet thread is DN20(external thread). Use well-insulated pipes to connect the water inlet and the house's water supply. Install the one way valve (thread RC3/4") in accessories to the inlet pipe to prevent water from flowing backwards.

CAUTION:

In any type of installation there should be a stop valve ((not provided) on the cold water inlet.

We recommend a supply pressure of 3~4 bar (0.3 to 0.4 MPa). If the inlet water pressure is less than 0.15MPa, a pump should be installed at the water inlet. If the main water supply pressure is higher than bar (0.7MPa), a reducing valve should be used at the water inlet pipe. The appliance cannot be connected by a hose-set.

For regions with a lot of scale ($T_h > 20^\circ\text{f}$), we recommend to treat the water. The hardness after softener has to be higher than 15 $^\circ\text{f}$. The use of a softener does not influence the warranty if the softener is approved for the country of installation and set to the rules of art, with regular checking and maintenance.

Local criteria of drinking water quality have to be respected.

2) Hot water connection

The spec of the water outlet thread is DN20(external thread). Use well-insulated pipes to connect the water outlet to the water terminal in the house.

CAUTION:

Water temperature over 50°C can cause severe burns instantly or death from scalds. We recommend installing a thermostatic mixer valve on the water delivery line.

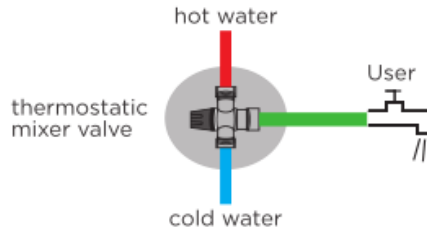

3) Drainage connection

The spec of the Drainage is NPT3/4. The unit comes with a plug. Replace the plug with a shut of valve and connect the unit to the drain pipe open to air.

4) Condensate evacuation

Connect the two condensate drain pipes in the fitting to the condensate outlet, as shown in fig.

Depending on the degree of humidity in the air you can get up to 0.25L/h of condensation. The condensate drain line should not be connected to the house sewer directly. Instead, use a siphon which contains water to prevent the unit from corrosive gases.

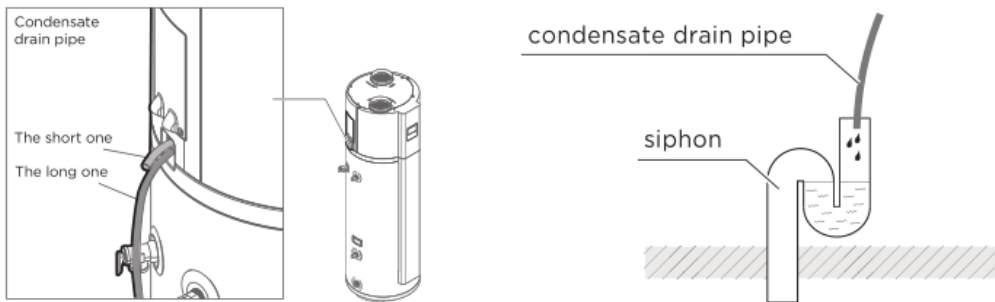

5) Installation of the pipe for PTR valve

The spec of the safety valve connecting thread is RC3/4" (internal thread) and it was installed already.

The overflow of the safety valve has to be connected to a drainpipe that is open to the air, and connect to the used water evacuation through a siphon. Installation has to be in a frost-free environment. The safety valve has to be operated regularly (every half year) to check the working condition.

CAUTION:

- In case of installing it at a place where outside temperature below freezing point, insulation must be provided for all hydraulic components.
- The handle of PTR valve should be pulled out once per half a year to make sure that there is no jam of the valve. Please beware of burn, beware of the hot water from the valve.
- The drainage pipe should be well insulated in order to prevent water inside pipe from freezing in cold weather.

⚠ WARNING



Do not block off the safety valve drainage pipe. It will cause explosion and injury, if do not comply with the above instruction.

Tips: Condensate may be leaked from unit if drainage pipe is blocked or unit operates in high humidity environment, a drainage pan is recommended as shown as following figure.

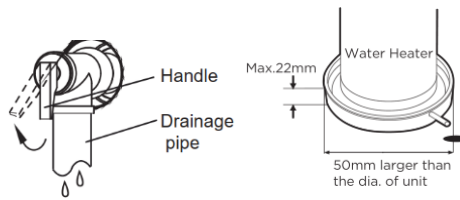

After water system piping work, turn on the cold water inlet valve and hot water outlet valve and start effusing the tank. Check pipeline to make sure there is not any leakage. When water flow smoothly out from water outlet pipe (tap water outlet), the tank is full, turn off all the outlet valves.

8.6 Air duct connection

It is strongly recommended to use rigid ducts meeting the following requirements:

- SWH-190P: Ø160mm, total length ≤ 5m;
- SWH-300P: Ø190mm, total length ≤ 10m;
- * 1 bend = 1m duct

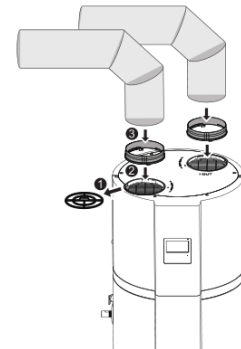

NOTE:

The resistance of duct will decrease air-flow-rate, which will lead to capacity of unit decreased.

For unit air outlet with duct, when unit operating, condensate will be generated around outside of duct. Please pay attention to the drainage work, we suggest to wrap the thermal insulated layer around outside of the duct.

Filter should be installed at the unit air inlet. In terms of the unit with duct, filter in there must be put on the position of duct inlet.

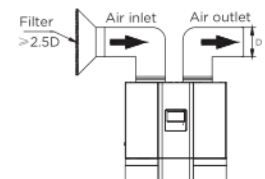

Owner should install the filter by self; and the mesh size is about 1.2mm.

1. Typical installation

Different ways of air ducts connection

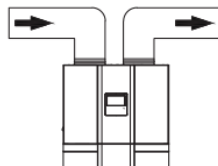

1. Air inlet and outlet with ducts.

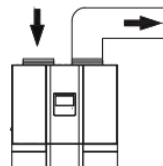

2. Air outlet connects to duct, air inlet without ducts.

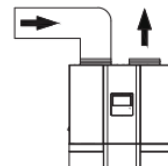

3. Air inlet connects to duct, air outlet without ducts.

Different directions of air ducts connection

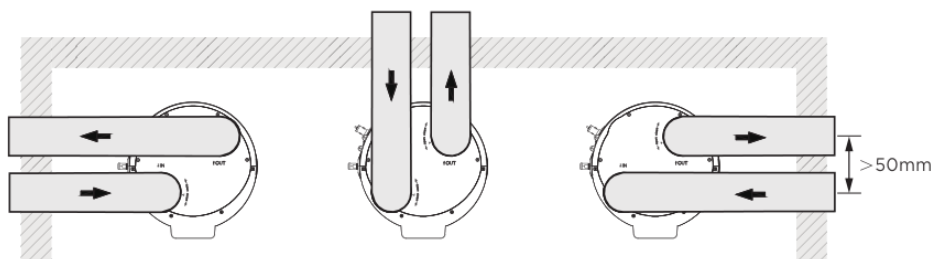

8.7 Electric connection

CAUTION:

The power supply should be an independent circuit with rated voltage.

Power supply circuit should be earthed effectively.

The wiring must be performed by professional technicians in accordance with national wiring regulations and this circuit diagram.

An all-pole disconnection device which has at least 3mm separation distance in all pole and a residual current device (RCD) with the rating of above 10mA (30 mA is recommended) shall be incorporated in the fixed wiring according to the national rule.

Set the electric leakage protector according to the relevant electric technical standards of the state.

The power cord and the signal cord shall be laid out neatly and properly without mutual interference or contacting the connection pipe or valve.

After wire connection, check it again and make sure the correctness before power on

1 Specifications of power supply

The recommended power cord model is H05RN-F.

You can choose the power cord according to the following table, and it should comply with local electric standard.

| | |
|---|----------------------|
| Power supply | 220-240V~, 50Hz, 1Ph |
| Min. diameter of power supply cord (mm ²) | 1.5 |
| Earth cord (mm ²) | 1.5 |
| Manual Switch(A) Capacity/Fuse(A) | 30/25 |
| Creepage Breaker | 30mA ≤ 0.1sec |

2 Power cord connection

The steps for connecting power cables are as follows:

- 1) Remove both screws and take of the junction cover; Remove both screws and take of the metal protective cover;
- 2) Route the power cable through the bottom cable hole; Connect the power cable to  , N, L and fix the cable with the below tie; The power cable should route through the left hole reserved on the junction box cover. Put the metal protective cover and junction box cover back.

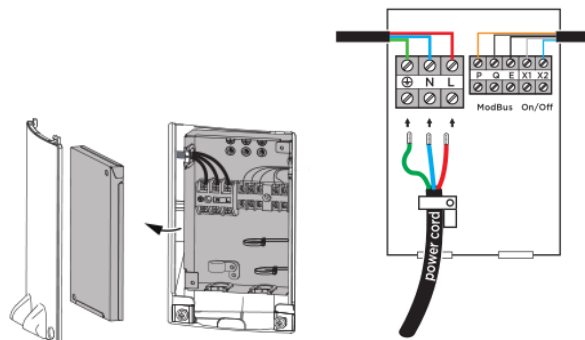

WARNING:

Ensure the ground wire has the longest length, to prevent it from being pulled.

CAUTION:

When wiring the power supply, please add additional insulation sheath at the place without rubber insulation layer.

WARNING:

The unit must be installed with a Creepage Breaker near the power supply and must be effectively earthed.

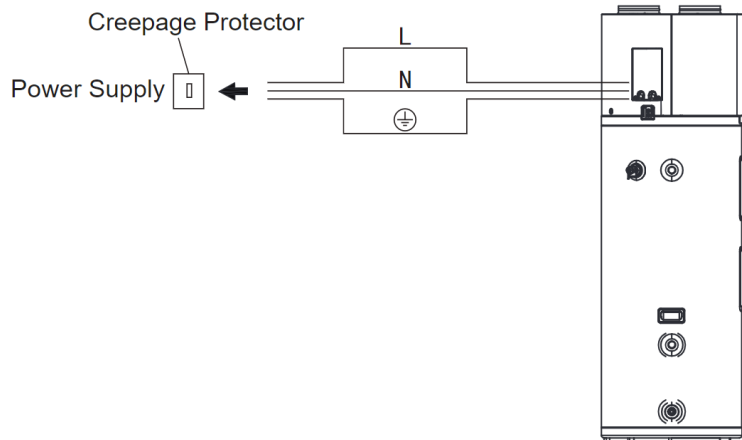

8.8 Installation checklist

Location & Space

- The floor must be able to bear the weight of the unit when filled with water.
- Located indoor such as a basement or garage) and in a vertical position. Protected from freezing temperature.
- Allow sufficient space for maintenance and service.
- Allow sufficient air for the heat pump to operate. The water heater heat pump must have unrestricted air flow.
- The unit cannot be placed into any type of closet or small enclosure.
- The site location must be free from any corrosive elements in the atmosphere such as sulfur, fluorine, and chlorine.

These elements are found in aerosol sprays, detergents, bleaches, cleaning solvents, air fresheners, paint, and varnish removers, refrigerants, and many other commercial and household products. In addition excessive dust and lint may affect the operation of the unit and require regular cleaning.

- The ambient air temperature must be above -7°C and below 43°C. If the ambient air temperature goes below this lower limits the electrical elements will be activated to meet the hot water demand and the heat pump will not operate.

Hydraulic connection

- PTR valve (Temperature and pressure relief valve) has to be properly installed with a discharge pipe going to an adequate drain and sheltered from freezing.
- All pipes must be properly installed and with no water leakage.
- Water temperature limit valve or mixer tap (recommended) has been installed.
- Condensate drain lines must be installed with an easy access.
- The condensate drain outlet must be at the lowest position of the unit.
- A siphon has been connected to the condensate drain pipes.

Electrical Connections

- The water heater requires 220-240 VAC for proper operation.
- Wiring size and connections comply with all local applicable codes and the requirements of this manual.
- Water heater and electrical supply are properly grounded.
- Proper overload fuse or circuit breaker protection installed.

Post Installation Review

Make sure the users understand how to use the User Interface Module to set the different modes and access the different functions.

Make sure the users understand the importance of routine inspection/maintenance of the condensate drain pan and lines. This is to help prevent any possible drain line blockage resulting in the condensate drain pan overflowing.

IMPORTANT: Water coming from the plastic shroud is an indicator that both condensation drain lines may be blocked. Immediate action is required.

To maintain optimal operation check, remove and clean the air filter.

8.9 PCB I/O Ports description

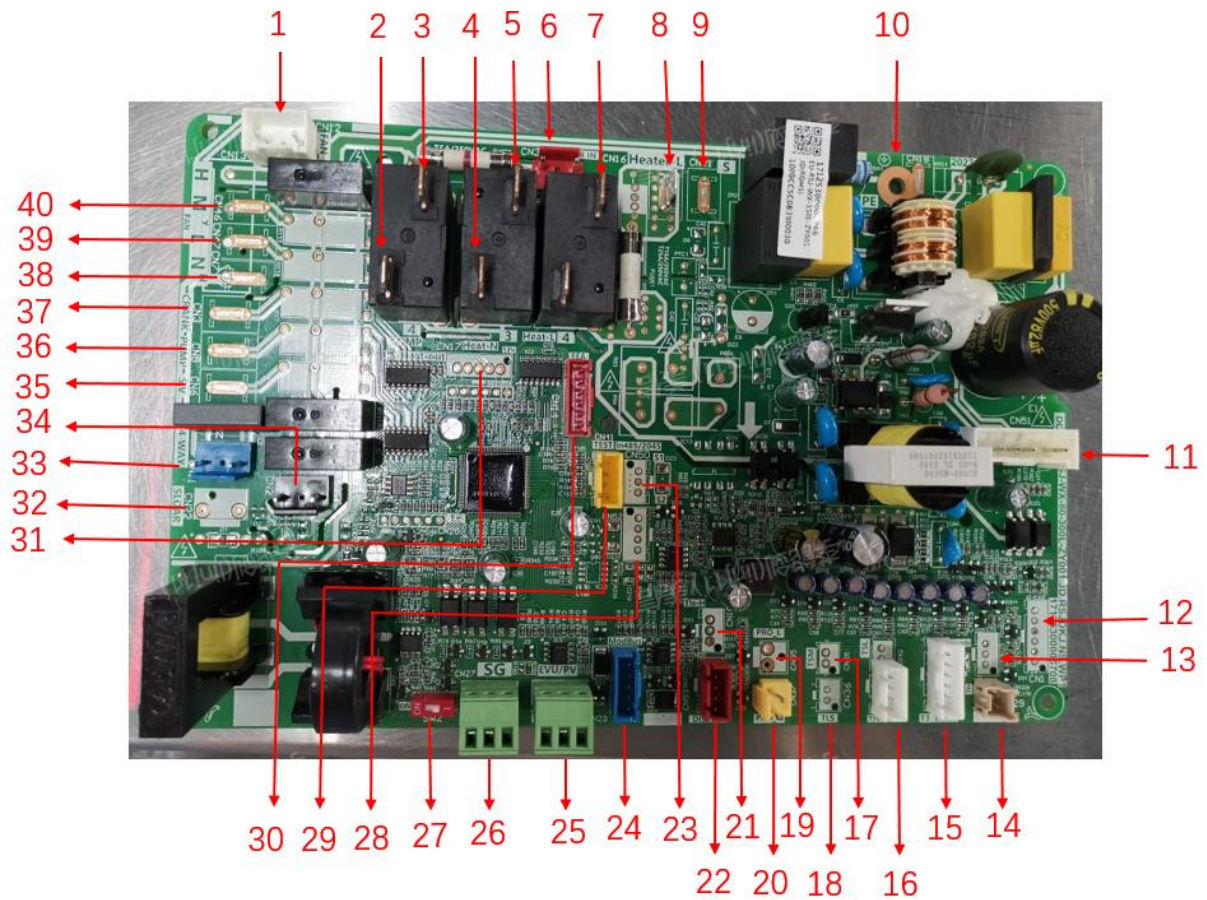

| No. | Name | CN# | Meaning | No. | Name | CN# | Meaning |
|-----|------------------------|-------|------------------------|-----|---------------------------------|------|--|
| 1 | FAN-H | CN12 | The outer Fan | 21 | TLS-H | CN10 | Water level switch for water leakage detection in the water tray |
| 2 | Comp out | RY1-4 | Comp output | 22 | DISPLAY | CN53 | DISPLAY |
| 3 | Comp in | RY1-3 | Comp input | 23 | in485/2045 | CN50 | North American 2045 port |
| 4 | E-heat-N-in | RY4-3 | Heat-N input | 24 | Modbus and remote switch On/Off | CN31 | Modbus and remote switch On/Off |
| 5 | E-heat-N-out | RY4-4 | Heat-N output | 25 | EVU/PV | CN23 | Photovoltaic signal |
| 6 | POWER-in | CN38 | Board power supply | 26 | SG | CN27 | Smart Grid |
| 7 | E-heat-L-out | RY2-3 | Heat-L output | 27 | Switch | SW2 | Factory Setting |
| 8 | E-heat-L-in | CN16 | Heat-L input | 28 | LM-det | CN52 | Refrigerant detection reserved port |
| 9 | S | CN21 | S-signal | 29 | TEST | CN41 | Test Port |
| 10 | PE | CN18 | Earth GND | 30 | EEA | CN34 | Electronic Expansion Valve |
| 11 | DC FAN | CN51 | DC FAN | 31 | 2 x E-heat | CN17 | Outlet E-heat control |
| 12 | Auto inlet water Valve | CN1 | Auto inlet water Valve | 32 | Solar Input | CN22 | Solar Input (strong current) |
| 13 | Anode | CN33 | E-MG | 33 | 4-Way | CN11 | 4-Way Valve |
| 14 | Th | CN29 | Comp Suction | 34 | Alarm | CN2 | Alarm |

| | | | | | | | |
|----|----------|------|---|----|-------|------|-----------------------|
| | | | Temp Sensor | | | | |
| 15 | T3/T4/Tp | CN28 | T3:Evaporator Inlet Temp T4:Ambient Temp Sensor TP:Comp Discharge Temp Sensor | 35 | S.V | CN6 | Electromagnetic valve |
| 16 | T5U/T5L | CN24 | T5U:Upper Tank Water Temp Sensor T5L:Lower Tank Water Temp Sensor | 36 | PUMP | CN5 | Solar Pump |
| 17 | T5M | CN26 | Middle Tank Water Temp Sensor | 37 | Crank | CN3 | Crank Heater |
| 18 | TLS | CN36 | Chassis leak detection | 38 | N | CN7 | N output |
| 19 | PRO-L | CN35 | LOW Pressure Switch | 39 | L | CN47 | Low Fan output |
| 20 | PRO-H | CN37 | High Pressure Switch | 40 | M | CN46 | Middle Fan output |

9. Use

9.1 Checking list before trial- running:

- ✧ Correct installation of the system.
- ✧ Correct connection of water/air piping and wiring.
- ✧ Smooth condensate drainage and proper installation of all hydraulics.
- ✧ Correct power supply.
- ✧ No air in the water pipeline and all valves opened.
- ✧ Effective electric leakage protector installation.
- ✧ Sufficient inlet water pressure (between 0.15MPa~0.7Mpa).
- ✧ Unit completely filled with water.

CAUTION: If the unit has been placed in horizontal position, keep it in a vertical position for at least 60min before start up.

9.2. Initial startup

Follow the steps below to start up the unit.

- 1) Filling the tank with water before operation

Please ensure that the tank is full of water before turning on the power. Water filled method is as follows:

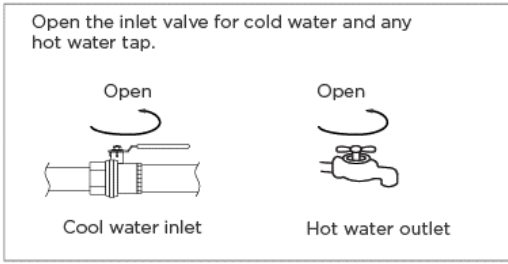

Water filling

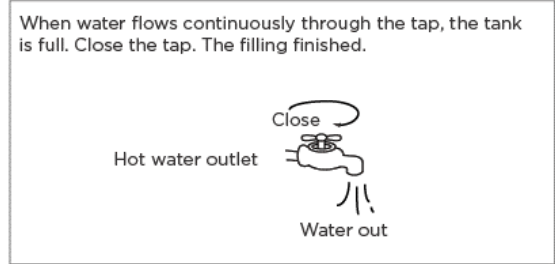

The water tank should be filled when the unit is used again after emptying.



Caution:

The water tank must be filled when using the unit again after emptying it.

Ensure that there is no water leakage in the pipe before starting up.

Operation without water in water tank may result in the damage of E-Heater. Manufacturer is not liable for any damages caused by this issue.

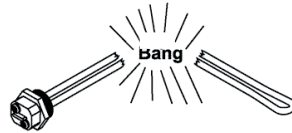

CAUTION:

If the unit needs cleaning, moving, stop using, etc., the tank should be emptied. Emptying Method is as follows:

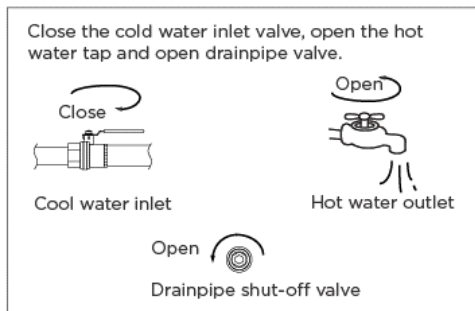

Emptying

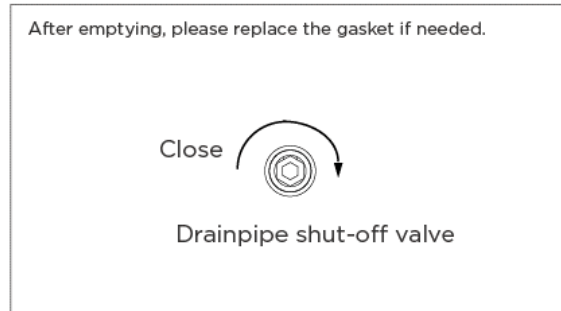



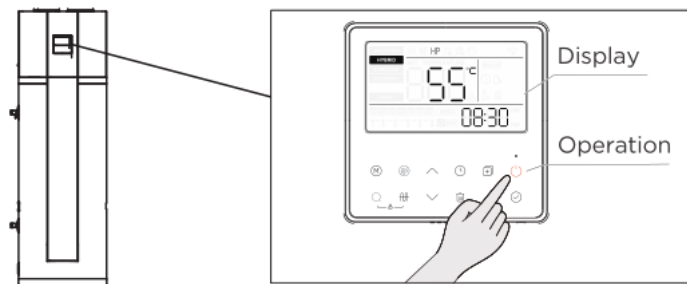

CAUTION: The water will flow through drainpipe shut-of valve! It could be hot! Pipe it into the sewage system!

2) Start up

After powered on, the display will light up.





- Press  → the unit will be switch on → press   to select the set temperature (38-70°C) → press  → The unit will automatically select heat source and start to heat water to set temperature.
- **Change the running mode**
Press the  button to select running mode.

Water temperature display

The temperature shown on the display is the maximum of the temperatures registered by the upper sensor and the lower sensor. It is possible that once the display shows that the setpoint temperature has been reached on one of the sensors, compressor still running, because the water temperature around the other sensor does not get to set temperature.

Heat source shift

- ◇ Unit has two kinds of heat sources: heat pump (compressor) and electric heater. Unit will automatically select heat sources to heat water to the target temperature.
- ◇ The default heating source is heat pump. If inlet air temperature is out of the range of heat pump, heat pump will stop running, the unit will shift automatically to activate E-heater, then if the inlet air temperature goes into the running range of heat pump again, it will stop E-heater and shift automatically to heat pump again.
- ◇ If the water set temperature is higher than Max. Temp (Heat pump), for the existing inlet air temperature, the unit will first activate the heat pump until Max. Temp (Heat Pump), then stop heat pump, and activate E-heater to heat the water continuously until the desired temperature is reached.
- ◇ Manually E-Heater operation is available. If manually activate the E-heater when heat pump running, E-heater and heat pump will work together until the water temperature gets to set temperature. So, if want to heat quickly, please manually activate E-heater.
- ◇ If system occurs some malfunctions, error code "EHHP" and  will be shown on the display, then heat pump will stop running, The unit will activate automatically E-heater as the backup heat source, but the code "EHHP" and  will be shown until power off. Refer to[TROUBLE SHOOTING]for details.

10. Maintenance

CAUTION: Always turn of your Air-source Heat Pump Water Heater system and disconnect its power supply before cleaning or maintenance.

Check the connection between the power supply plug and socket and ground wiring regularly;

It is recommended to set a lower temperature if the outlet water volume is sufficient, to decrease the heat release, prevent scale and save energy.

If the system will be stopped for a long time, please do as follows to avoid freezing of inner tank and damage of E-heater:

- Shut off the power supply;
- Release all the water in water tank and the pipeline and close all the valves;
- Check the inner components regularly.

Clean the air filter every month in case of any inefficiency on the heating performance. In terms of the filter set in air

inlet directly (namely, air inlet without connecting with duct):

- Unscrew the air duct connector anti-clockwise.
- Take out the filter and clean it completely;
- Remount it to the unit

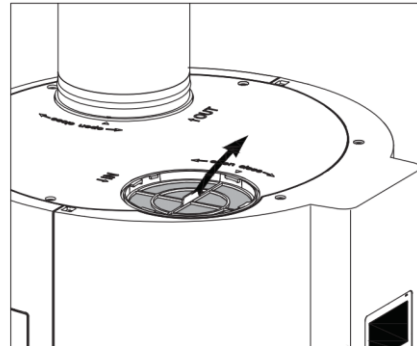
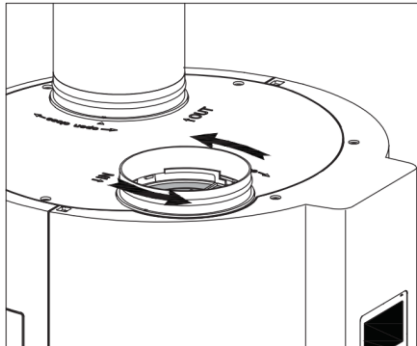

Operate and check the PTR valve every 6 months to prevent blockage.

CAUTION: The following maintenance items need to be performed by qualified persons. Please contact the supplier or the after sale service.

It is recommended to clean the E-heater every 6 months to maintain efficient performance.

Check the Magnesium rod every 6 months and change it if it has been used out.

Please contact professional technical after-sales service if the battery needs to be replaced.

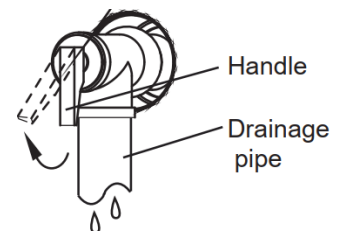

Recommended regular maintenance table

| Checking item | Checking content | Checking frequency | Action |
|---------------|--------------------|--------------------|-----------------------------------|
| 1 | Air filter (inlet) | Every month | Clean the filter. |
| 2 | Magnesium rod | Every half year | Replaced if it has been used out. |
| 3 | PTR valve | Every half year | Check for blockage |
| 4 | E-heater | Every half year | Clean the E-heater. |

For more details, please contact the supplier or the after-sale service.

Restart after a long term stop

When the unit is restarted after a long term stop (trail running included), it is normal that outlet water is unclean. Keep the tap on and the water will be clean soon.

11. Trouble shooting

Error phenomenon shooting

| Error phenomenon | Possible reason | Solution |
|--|--|---|
| Cold water tapped out and display screen extinguished. | Bad connection between power supply plug and socket | 1. Plug in; 2. Setting water temp. higher; 3. Contact service center. |
| | Setting water temperature too low. | |
| | Temperature sensor broken. PCB of indicator broken. | |
| No hot water tapped out. | Public water supply ceased. | 1. Waiting for water supply recover. 2. Waiting for the pressure increase. 3. Open water inlet valve. |
| | Cold water inlet pressure too low (<0.15 MPa). | |
| | Cold water inlet valve closed. | |
| Water leakage | Hydraulic pipeline joints are not sealed well. | Check and reseal all joints. |

Malfunction and protection codes

| Code | Content |
|------|---|
| EH0b | Tank and wired controller communication error. |
| EH00 | EEPROM chip error |
| EH03 | Dc fan fault |
| PH15 | Electric leakage protection |
| EC54 | Compressor discharge temperature sensor TP error. |
| EH5H | Compressor suction temperature sensor TH error |
| EC53 | Ambient temperature sensor T4 error. |
| EC52 | Evaporator temperature sensor T3 error. |
| EC5L | Error of sensor T5L (Lower water temperature sensor). |
| EC5U | Error of sensor T5U (Upper water temperature sensor). |
| EH5N | Error of sensor T5M (Solar temperature sensor). |
| EH5d | E-heater open-circuit error |
| EHLA | When the ambient temperature T4 is out of the compressor operating range, the compressor stops, and EHLA is displayed until T4 returns to the normal range. Only works on units without electric heaters. Devices with electric heaters will never display "EHLA" It is normal, and no necessary to repair. |
| EHHP | Heat pump system fault. When PH20, PH21, PC30, PC06 any protection appears 3 times or the protection lasts 1 hour. |
| PHdH | Dry burning protection |
| PH20 | Compressor abnormally stopped protection |
| PH21 | Compressor overloaded protection |
| PH24 | Anti-freeze protection for low-temperature conditions T5L < 4°C and T4 < 7°C |
| PC30 | System high pressure protection ≥3.0MPa active; ≤2.4Mpa inactive |
| PC06 | High discharge temperature protection.. Tp>110°C, Protection active. Tp<90°C, Protection inactive |
| PH9b | Over-temperature protection The current water temperature exceeds the target temperature by more than 5°C |
| PH91 | Anti-freeze protection for refrigeration status |

T3<-30°C lasting for 10s, Protection active. T3≥-30°C, Protection inactive

EH0b

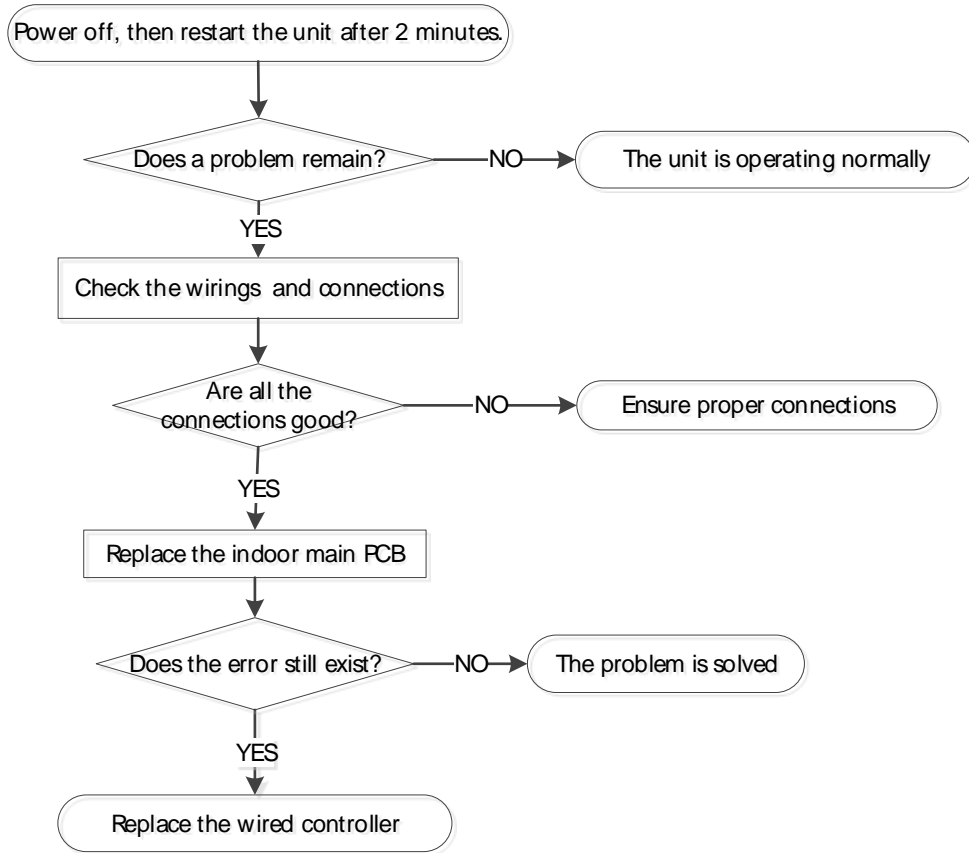

EH00

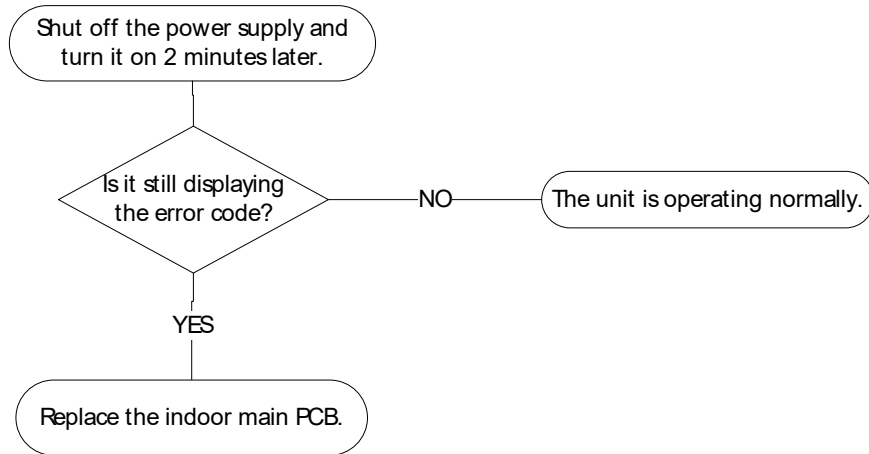

EH03

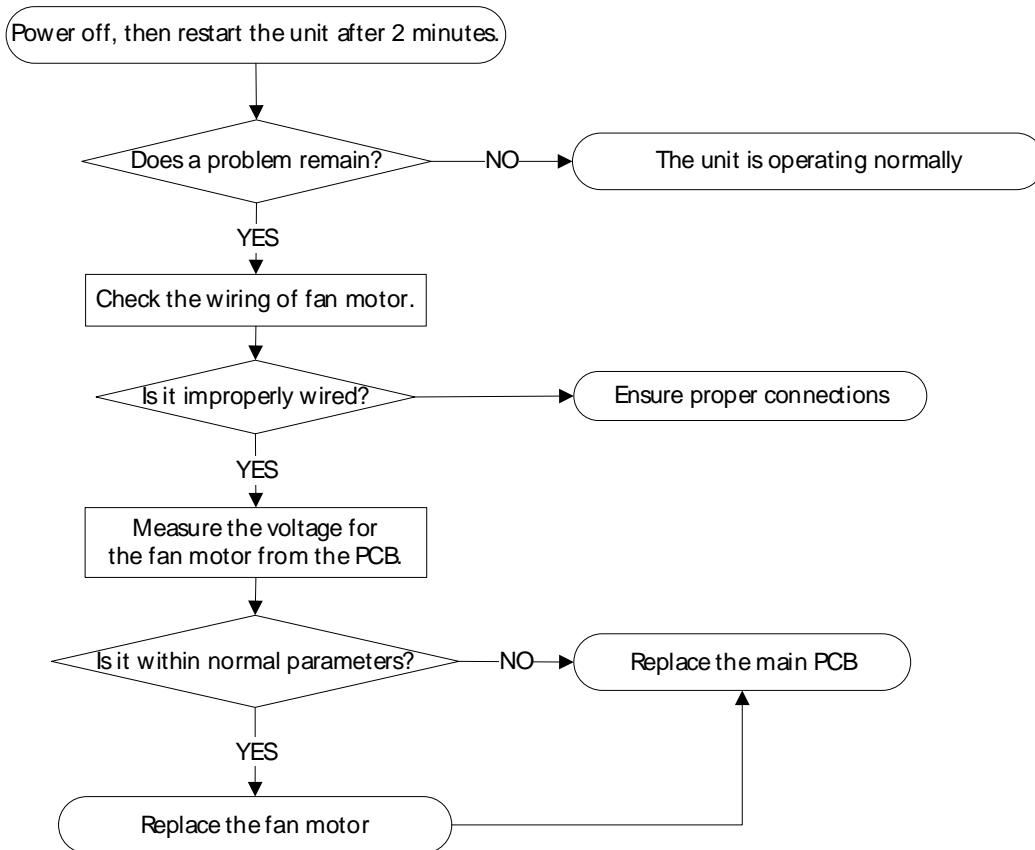

PH15

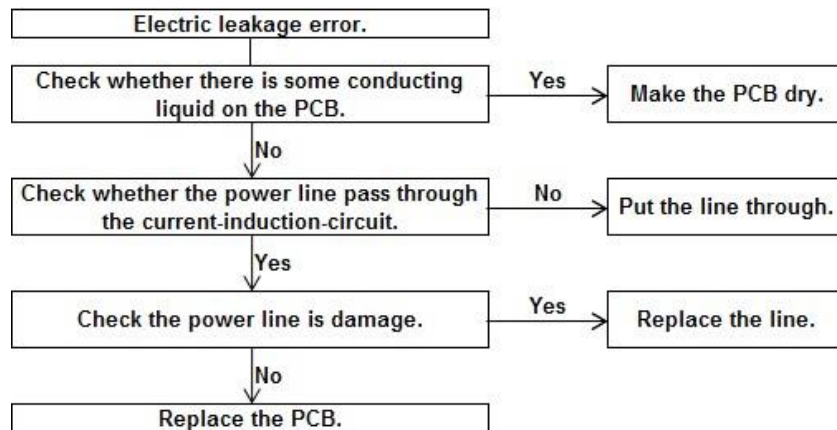

EC52, EC53, EC54, EH5H

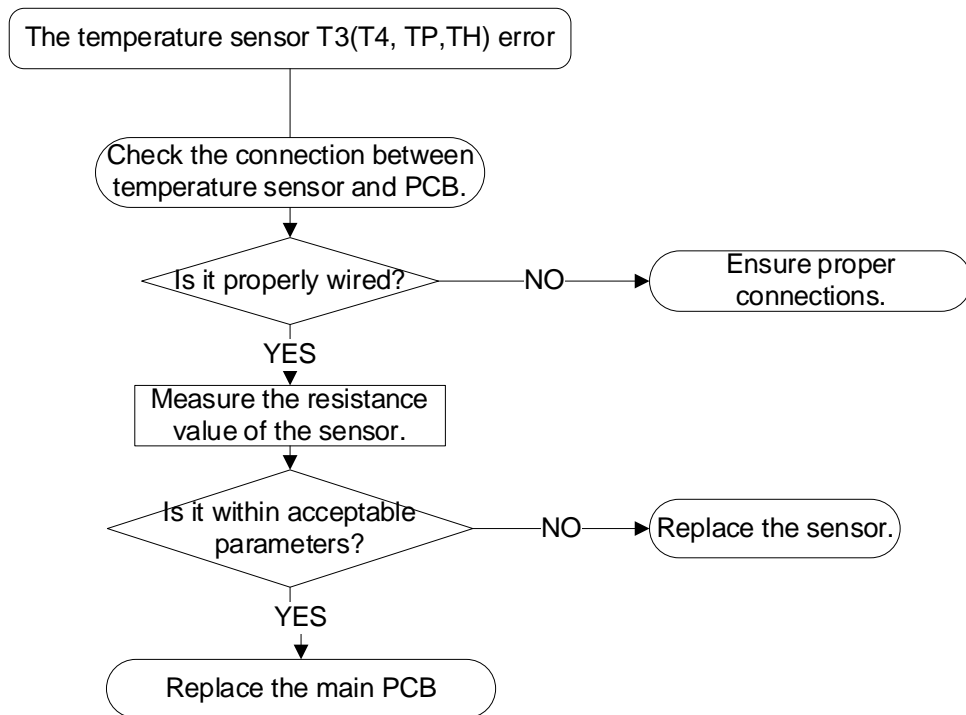

Notes: T3 is the evaporator temperature sensor.
T4 is the ambient temperature sensor.
TP is the compressor discharge temperature sensor.
TH is the compressor suction temperature sensor:

EH5U, EH5L, EH5N

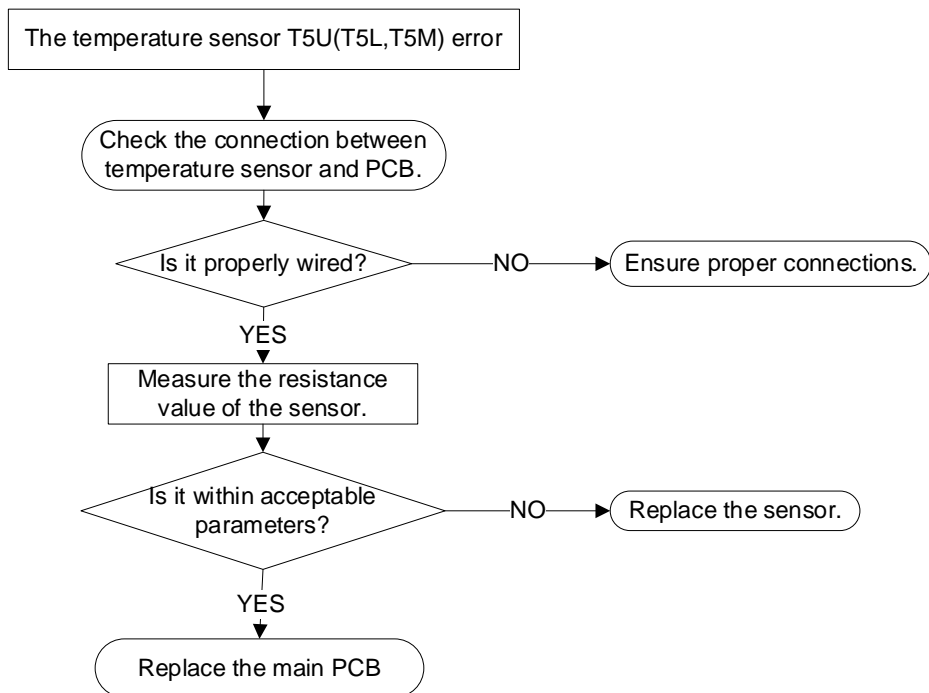

Notes:

T5U is the upper water temperature sensor.

T5L is the lower water temperature sensor.

T5M is solar temperature sensor.

EH5d

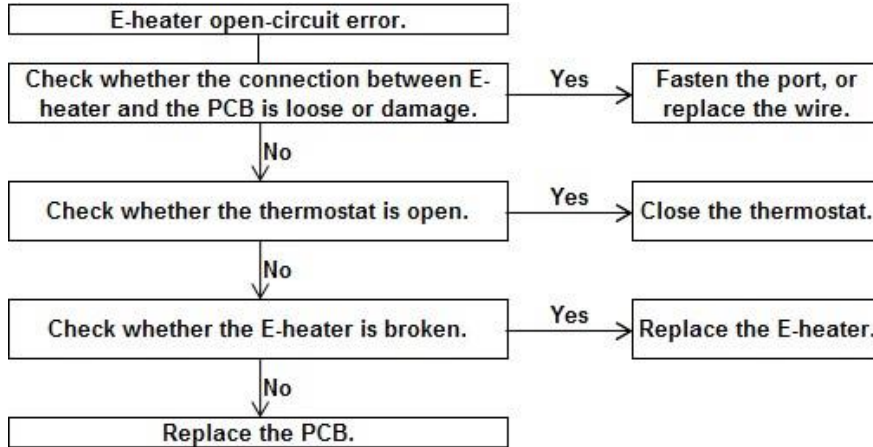

Notes:

E-heater open-circuit error means that IEH (Current difference E-heater on and off) <2A.

PHdH

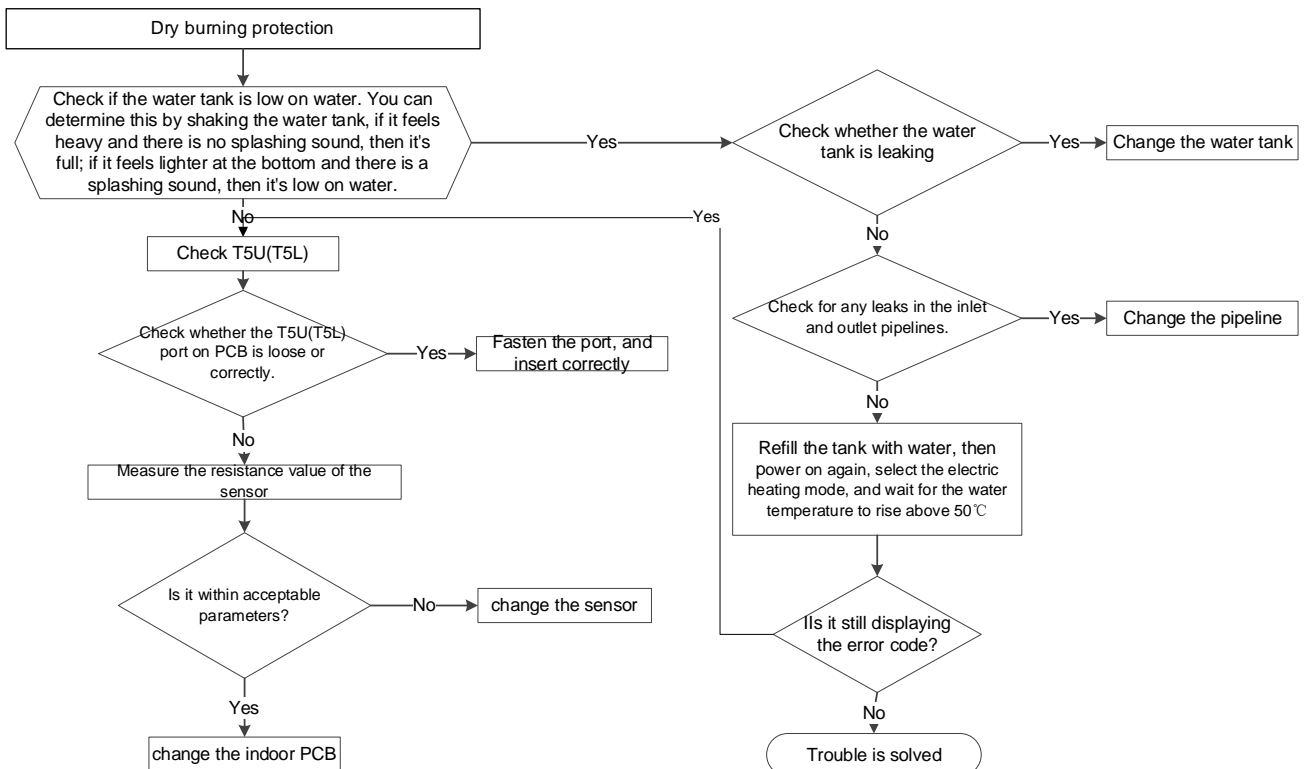

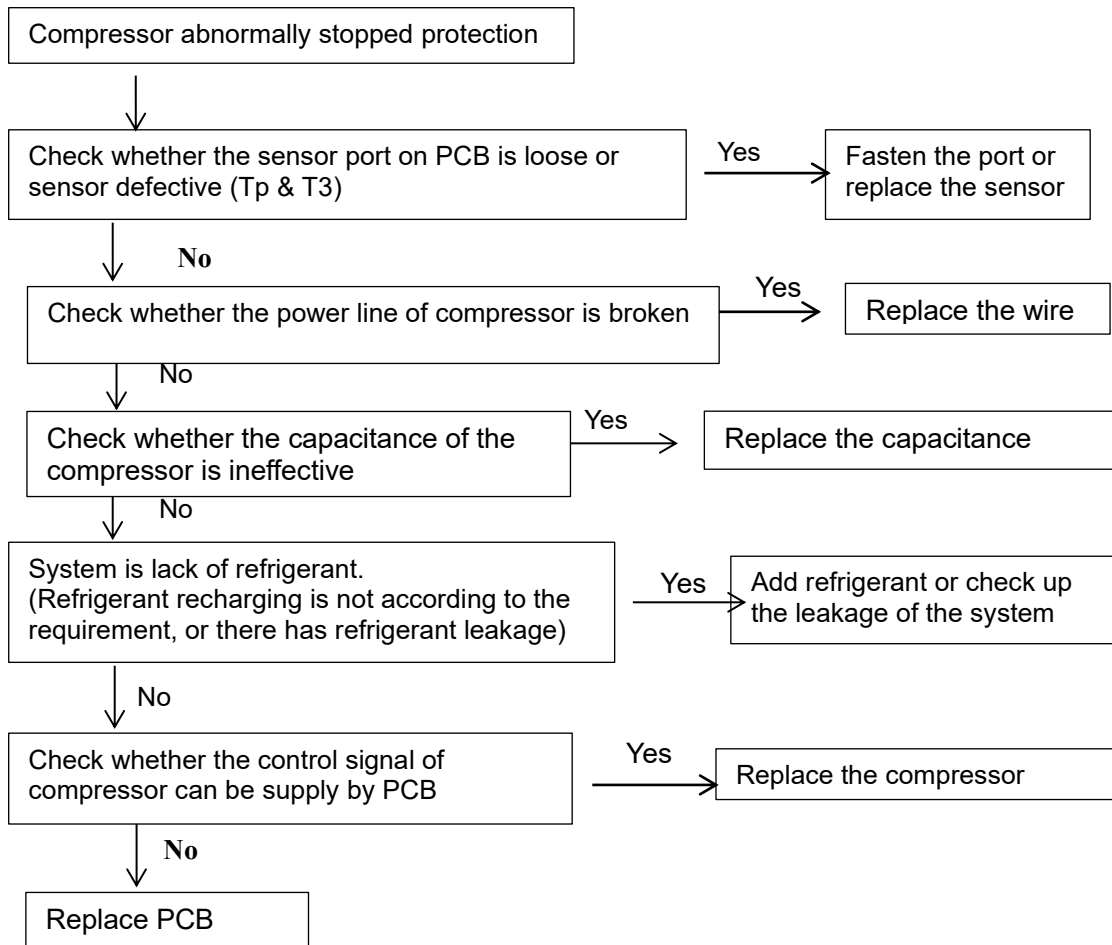

Notes:

The discharge temperature is not so higher than evaporator temperature after compressor running a term..

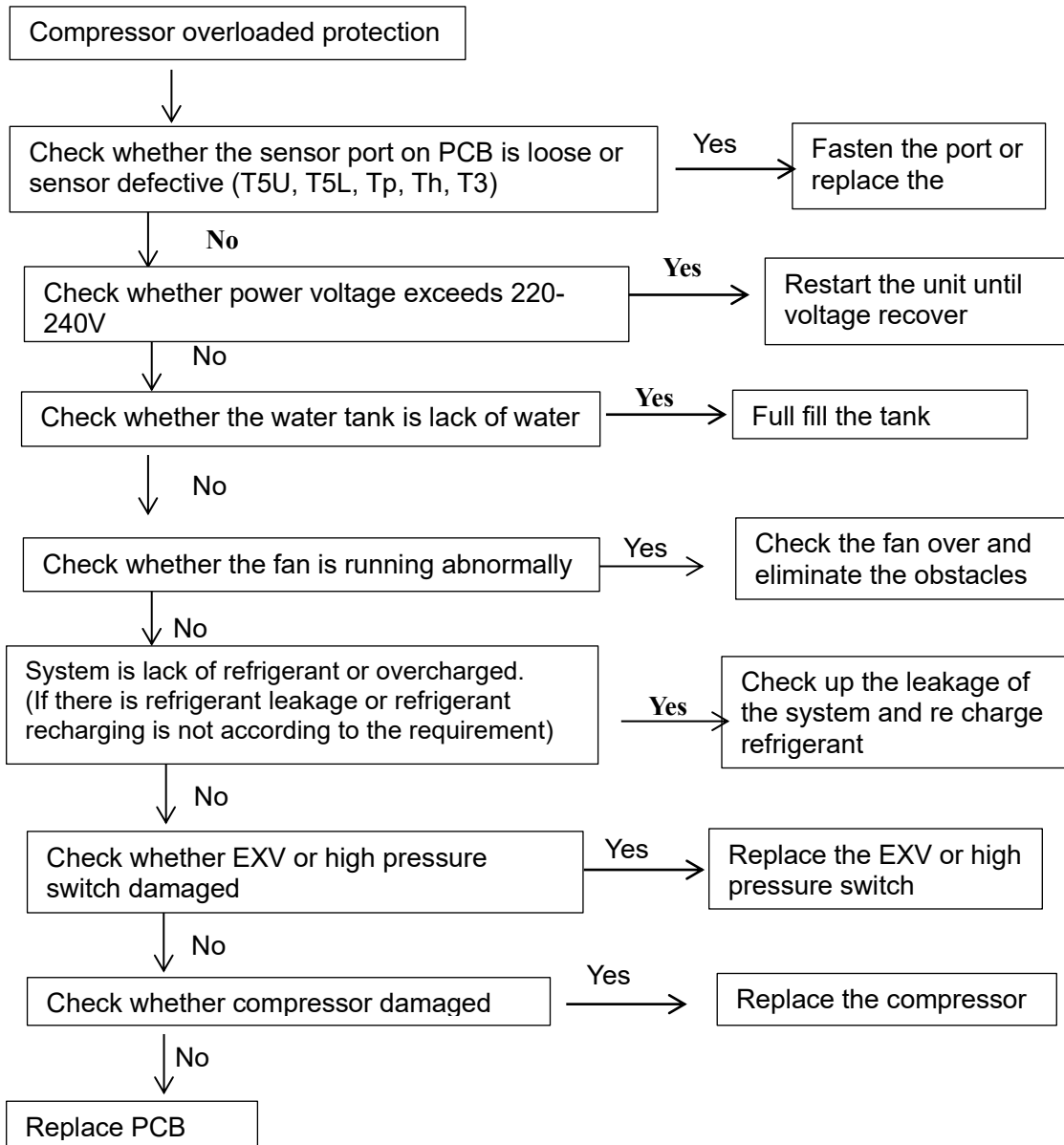

Notes:

10 s after compressor startup, current checking starts,

1) Only compressor running, if it is >6A, the compressor will be stopped and protected

2) Compressor and E-heater running at the same time, if it is >15A, the compressor will be stopped and protected.

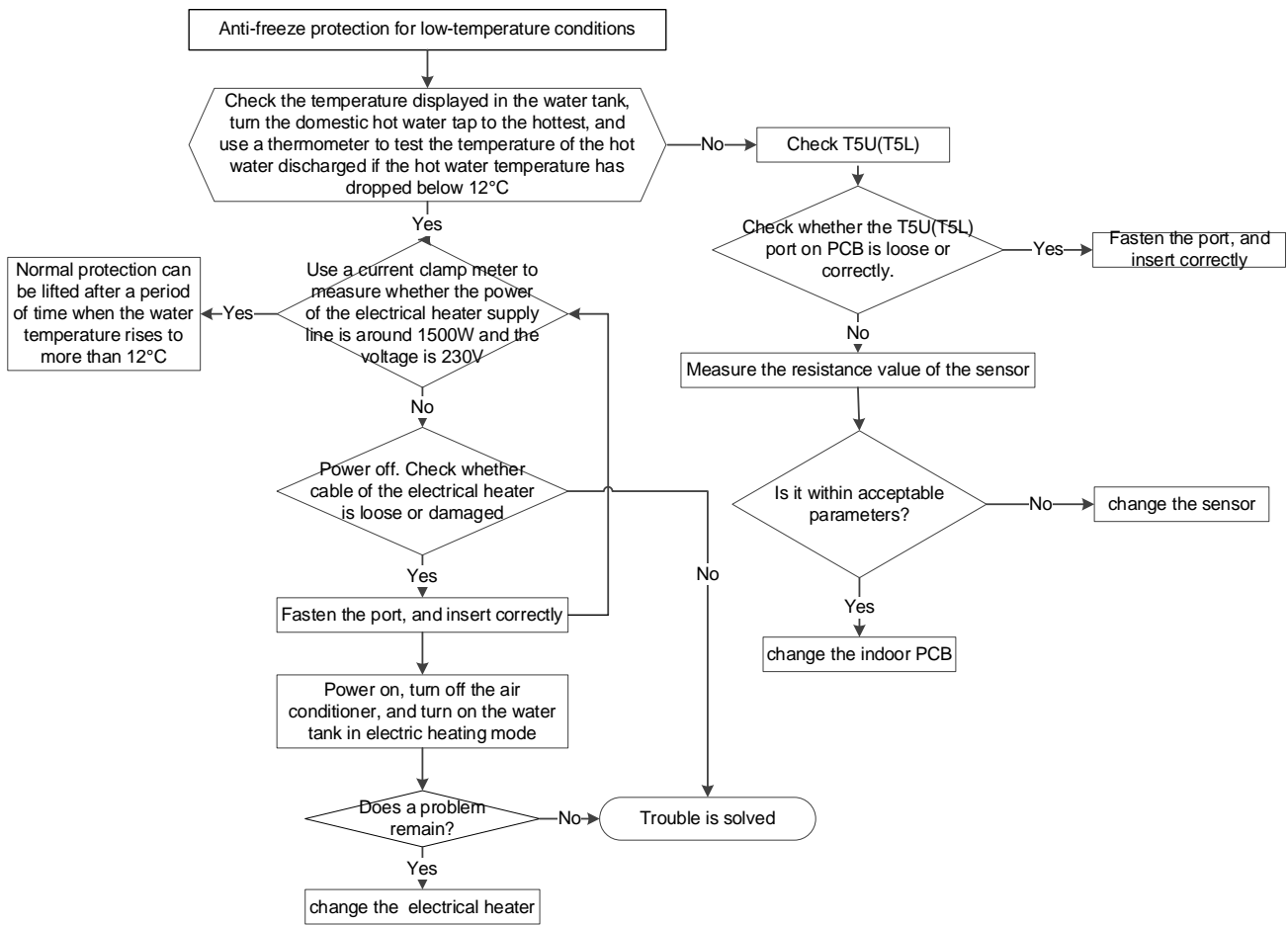

PC30

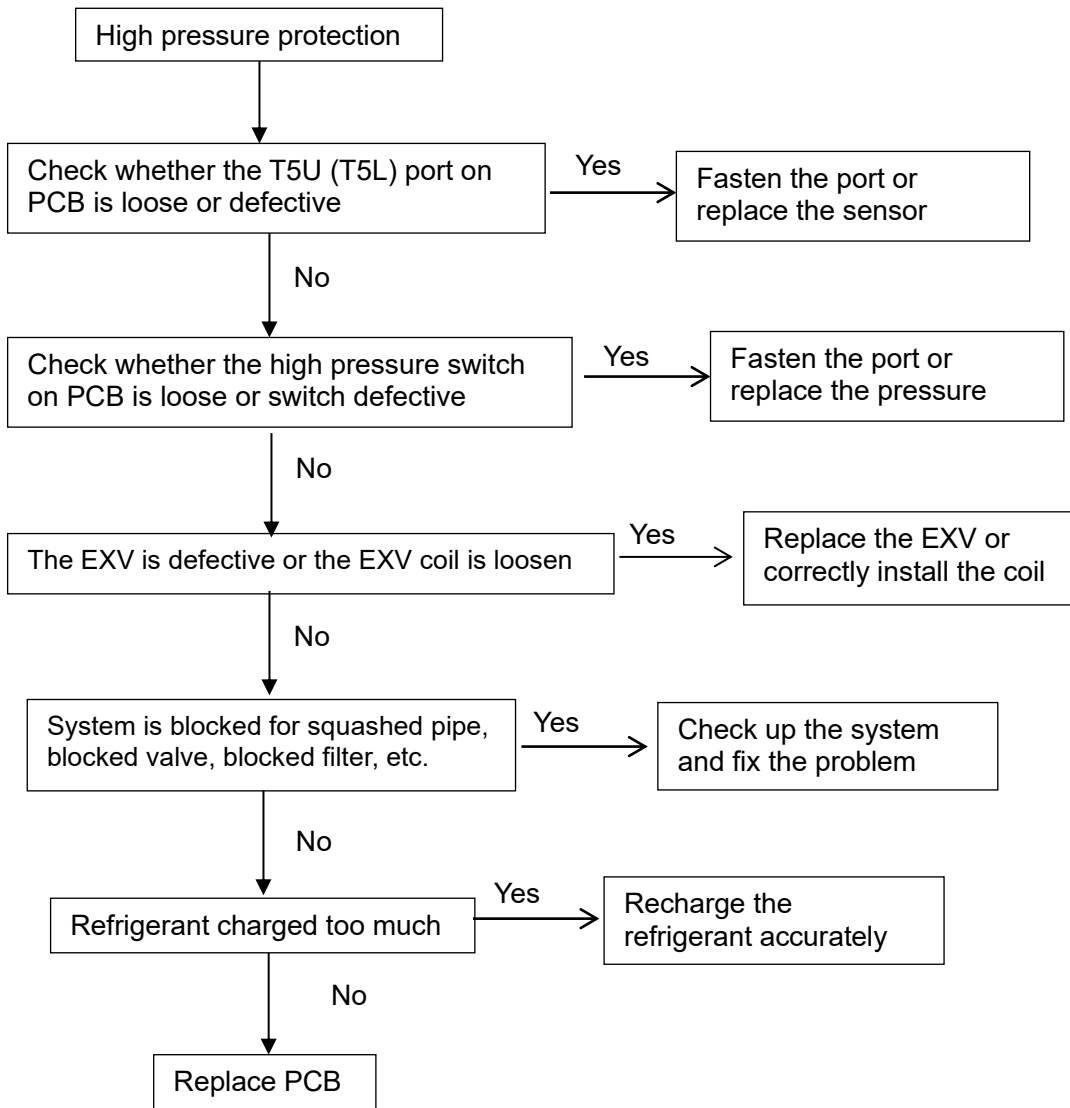

Notes:

When the discharge pressure of compressor is 3.0Mpa or higher, the protection switch will be triggered.

If the discharge pressure is down to 2.4MPa, the protection switch will be recovered.

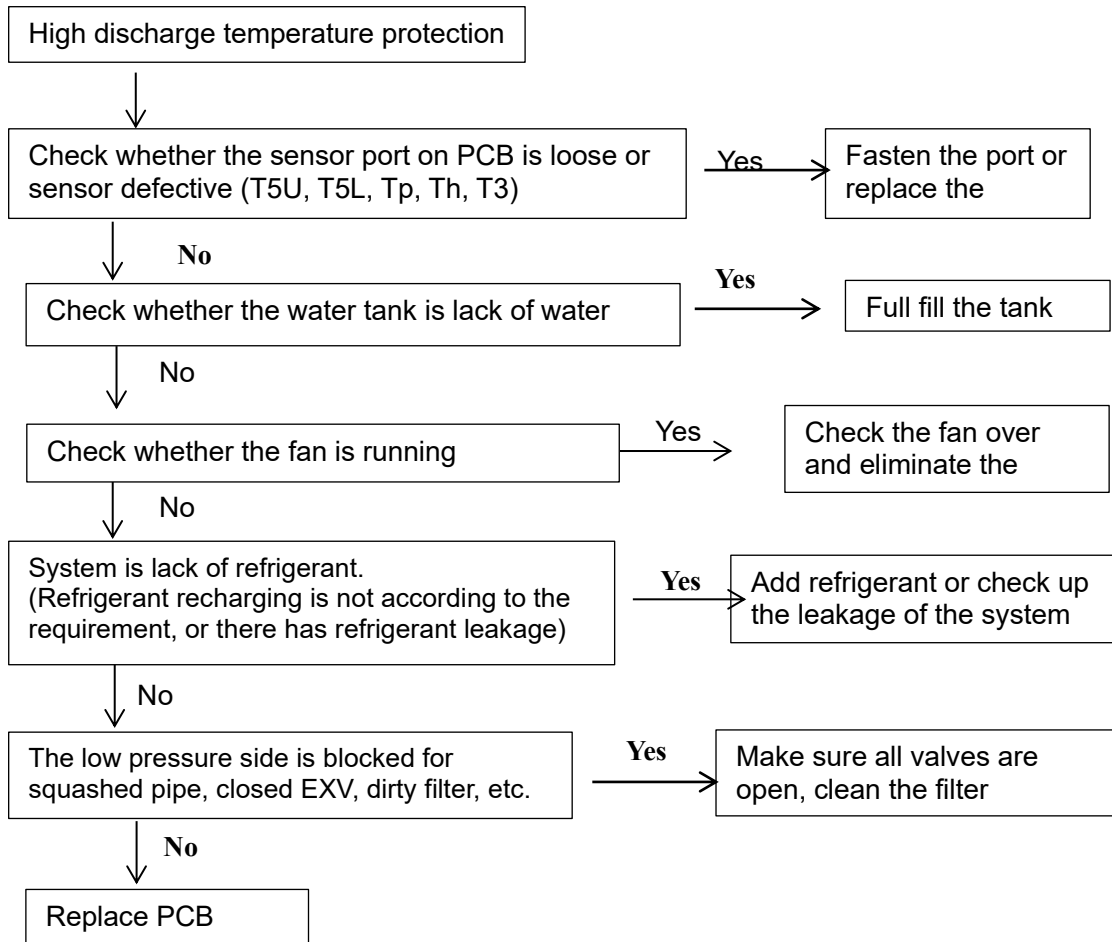

Notes:

When $T_p > 110^{\circ}\text{C}$, high discharge temperature protection P2 active.

When $T_p < 90^{\circ}\text{C}$, high discharge temperature protection P2 inactive.

PH9b

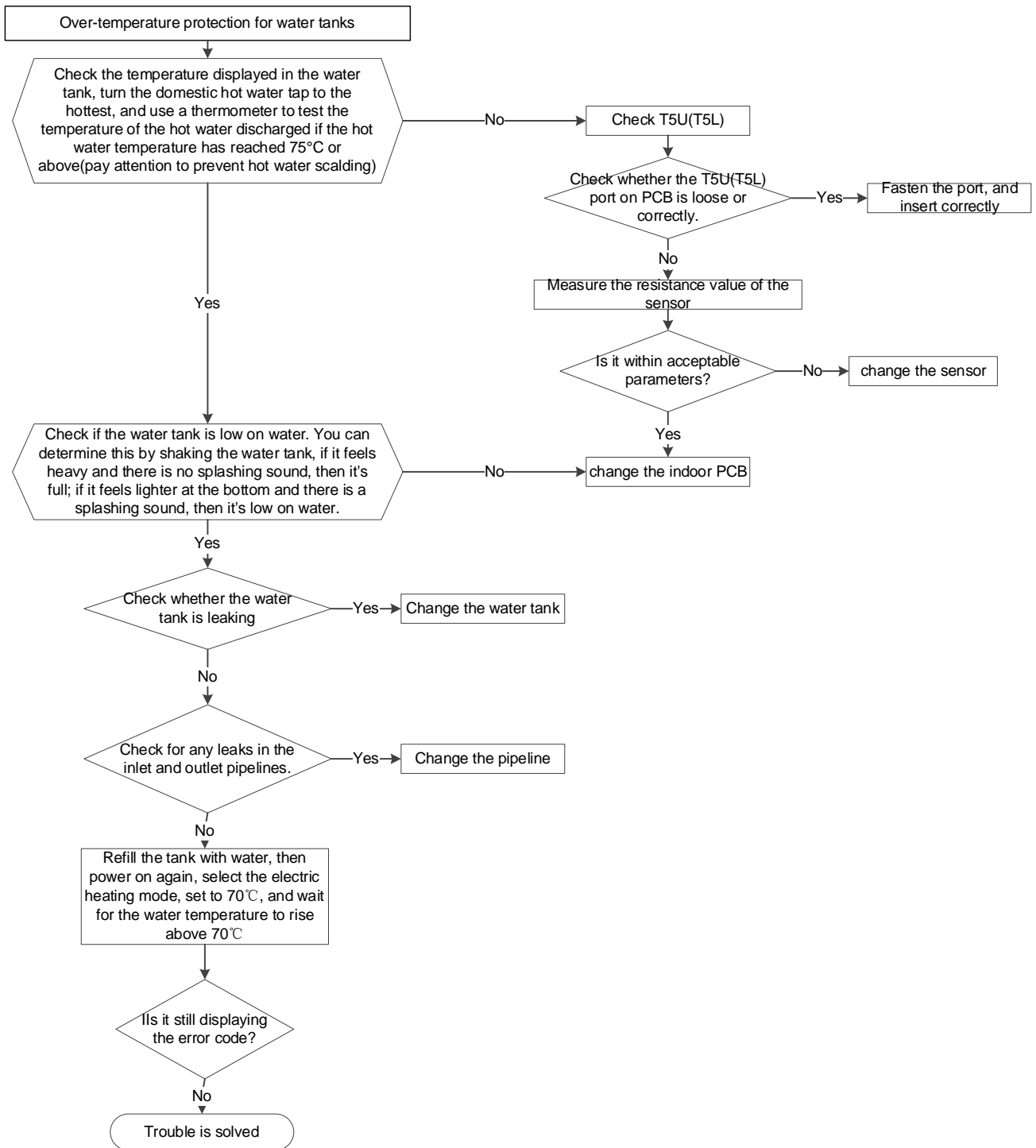

PH91

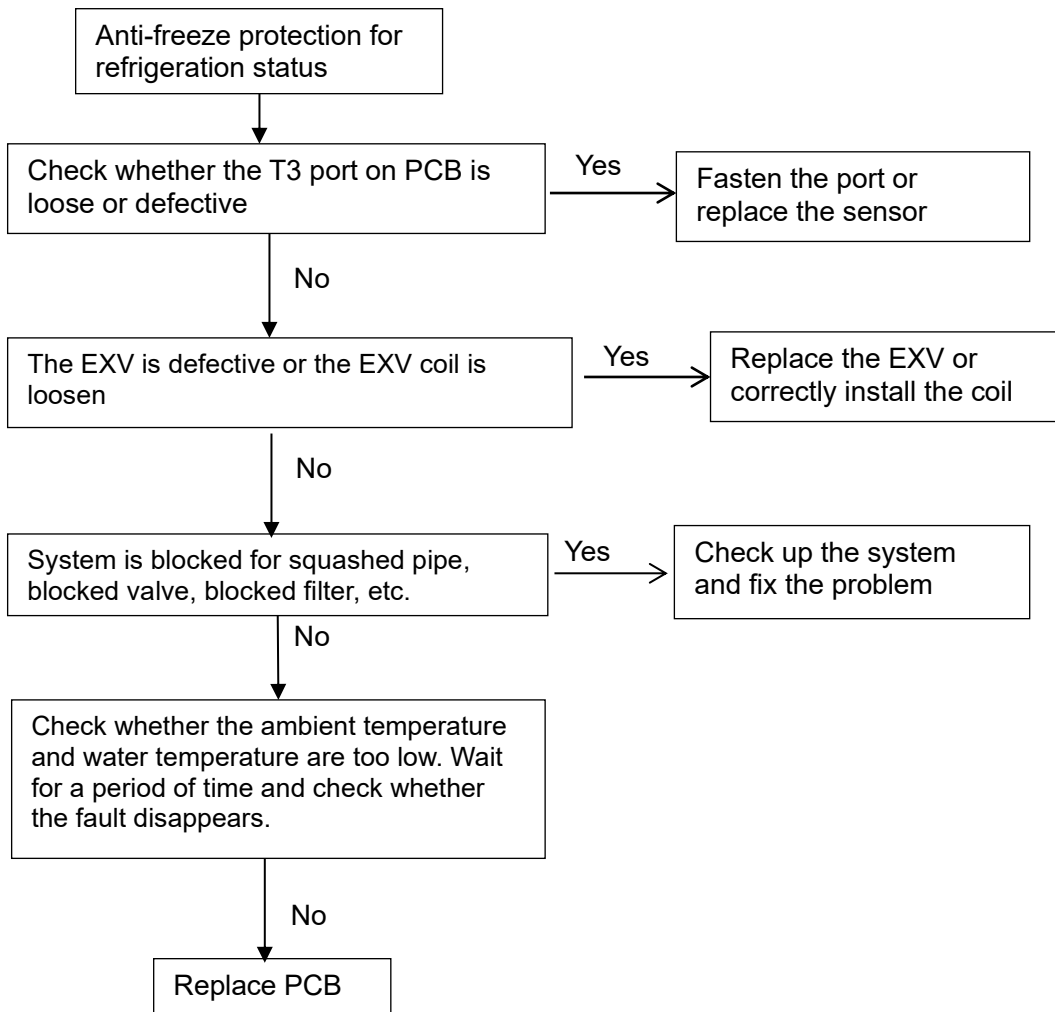

12. Function

Weekly Disinfect

Under disinfection mode, the unit will immediately start to heat water up to 65°C to kill the potential legionella bacteria

inside water tank.  icon will light on the display screen during disinfection. Unit will quit disinfection mode if water

temperature is higher than 65°C and extinguish  icon.



Vacation function

After pressing  button to select VACATION, unit will automatically heat water to 15°C for the purpose of energy saving during vacation days.

Remote shutdown function

Users can connect a switch. If the switch is closed, the unit will be stopped forcibly. If switch breaks, the unit can run normally according settings.

Query function

Pressing  for 1s then system running parameters will be shown one by one with following sequence by each pushing of  or  button.



| No. | Hour low bit | Min. high bit | Min. low bit | Unit | Explanation |
|-----|--------------|---------------|--------------|----------------------|---|
| 1 | T | S | U | Temp./ °C | T5U |
| 2 | T | S | L | Temp./ °C | T5L |
| 3 | T | S | I | Temp./ °C | --- |
| 4 | | T | S | Temp./ °C | Heat pump stop temp |
| 5 | | T | 3 | Temp./ °C | T3 |
| 6 | | T | 4 | Temp./ °C | T4 |
| 7 | | T | P | Temp./ °C | TP |
| 8 | | T | H | Temp./ °C | Th |
| 9 | | o | n | | --- |
| 10 | T | F | r | | --- |
| 11 | | T | T | Temp./ °C | Disinfect temperature |
| 12 | | L | o | Current | Compressor and electric heating current |
| 13 | | F | o | Wind speed range | Dc Fan: Real speed/10 |
| 14 | | E | o | Parameters check sum | 0~255 |
| 15 | E | E | r | | Electronic expansion valve opening |
| 16 | E | E | L | | Compression mechanism hot water demand |

| | | | | | |
|----|---|---|---|------------------------------------|---|
| 17 | P | U | P | | --- |
| 18 | | P | S | | --- |
| 19 | | F | T | | 0: Ac Fan 1: Dc Fan |
| 20 | | H | T | | 1(E-heater control type) |
| 21 | | H | P | | 0(Compressor control type) |
| 22 | F | S | I | | --- |
| 23 | S | I | o | | Tank capacity |
| 24 | P | 4 | P | | Four-way valve status |
| 25 | | U | U | | 0: Integral water heater |
| 26 | | U | I | Version | Host software version |
| 27 | | U | 2 | Version | LCD panel software version |
| 28 | | U | 3 | Version | 000 |
| 29 | | U | 4 | Electric heating code | 0: One electric heater 1: Two electric heaters |
| 30 | | U | T | machine code | 3 |
| 31 | I | E | r | Fault codes | Last error code |
| 32 | 2 | E | r | Fault codes | Previous 1st error or protection code |
| 33 | 3 | E | r | Fault codes | Previous 2nd error or protection cod |
| 34 | H | H | H | Maintenance Run Time | Maintenance time |
| 35 | T | L | F | Logic operation target temperature | Target temperature |
| 36 | E | n | d | --- | END sign |



Auto-restart function

If electricity power failed, unit can memorize all setting parameters, and unit will be back to the previous setting when power recovers.

Button auto-lock

When there is no operation of button for 1 minute, button will be locked except Unlock button  +  for 2s, unlock buttons.

Screen auto lock

If there is no operation of button for 60s, screen will be locked (extinguished) . Push  +  simultaneously for 2s to unlock buttons. Enter engineering mode 35 channel enable this function.

Parameter setting

In off state, press **COPY button for 3 seconds**, to enter the engineering mode and reset the parameters.

| Code | Definition | Default | Setting instruction | Code | Definition | Default | Setting instruction |
|-------------------|---|---------|--|--|---|----------------------|---|
| Channel 1 | Unit conversion (APP does not have this function) | 0 | 0-Centigrade; 1-Fahrenheit | Channel 17 | Set temp for auto-disinfection | 190L: 70 300L: 65 | Step size 1, (60-70) unit: °C |
| Channel 2 | Maintenance reminder function | 1 | 0-Off; 1-On | Channel 18 | Set maximum temp upper limit | F&S : 70 | Step size 1, (65-70) unit: °C |
| Channel 3 | Set time for maintenance reminder | 365 | Step size 10 (long press), Step size 1, (short press), Set range:30-365, unit: day | Channel 19 Channel 20 Channel 22 Channel 24 Channel 25 | -- | -- | -- |
| Channel 4 | Clear time accumulation for maintenance reminder | / | 0-not clear ; 1-clear | Channel 21 | Set 485 communication address | 1 | Step size 1, Set range:1-20 |
| Channel 5 | Clear fault code | / | 0-not clear ; 1-clear | Channel 23 | Reset factory data | 0 | 0-Off; 1-On |
| Channel 6 | the electric heater (for internal use only) | 1 | 0-Off; 1-On | Channel 26 | Set time for auto-disinfection (min) | / | Step size 1, Set range:0-59, unit: min |
| Channel 7 | Auto-disinfection | off | 0-Off; 1-On | Channel 27 | Electric heater forced compensation (ECO mode) | 190L: 0 300L: 1 | 0-Off; 1-On |
| Channel 8 | Set operating temp of the electric heater | 5 | Step size 1, (-5-5), unit: °C | Channel 28 Channel 29 | -- | -- | -- |
| Channel 9 | Set start time for auto-disinfection (h) | 23:00 | Step size 1, Set range:0-23, unit: h | Channel 30 | Automatic backlight | 1 | 0-Off, (all the time) 1-On, normal mode) |
| Channel 10 | Smart mode (for internal use only) | 0 | 0- With reference period 1- no reference period, mode 1 2- no reference period, mode 2 | Channel 31 Channel 32 Channel 33 Channel 37 Channel 38 Channel 39 | -- | -- | -- |
| Channel 11 | Set temp for vocation mode | 15 | Step size 1, (10-20) unit: °C | Channel 34 | Set keytone (buzz) | 0 | 0-with buzz 1-no buzz |
| Channel 12 | Set Ventilation mode(optional) | 0 | 0-off; 1-low fan speed, 2- middle fan speed, 3-high fan speed | Channel 35 | Auto- child lock | 0 | Without button operation in 1 minute 0-Off; 1-On |
| Channel 13 | -- | -- | -- | Channel 36 | Set temp difference (if the difference between the temperature detected by lower temperature sensor T5L and setting temperature is bigger than this set value, the HP will operate) | 190L: 8 300L: 12 | Step size 1, Set range:2-20, unit: °C |

| | | | | | | | |
|-------------------|--|-----------------------|---|---|--------------------------------|----------------------------------|---|
| Channel 14 | Set time for electric heater forced compensation | 190L: 60 300L: 840 | 190L: Step size 10, (10-300) unit: min 300L: Step size 10, (10-1500) unit: min | Channel 40 | ESP setting (under developing) | 190L: No this function 300L:1 | 0-0-20pa 1-20-40pa 2-40-60pa 3-60-80pa |
| Channel 15 | Burned protection (for internal use only) | 1 | 0-Off; 1-On | Channel 41 Channel 42 Channel 43 | -- | -- | -- |
| Channel 16 | Current detection function (for internal use only) | 1 | 0-Off; 1-On | | | | |





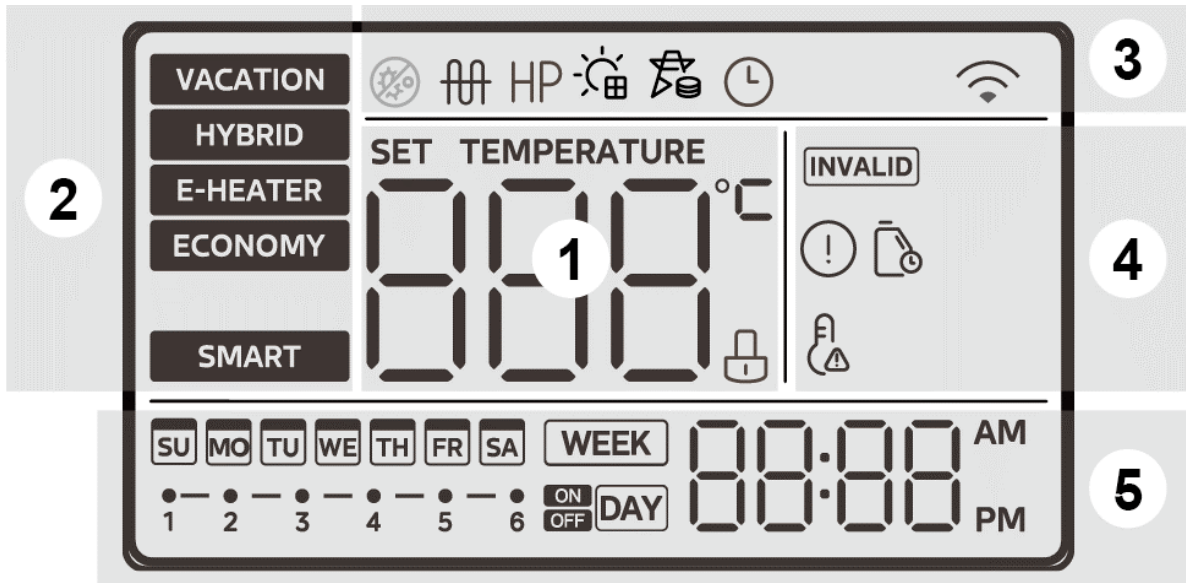





13. Operation







13.1 Display explanation



| Area | Icon | Description |
|------------------|-----------------|---|
| 1 Information | | 000 will be lighted if screen is unlocked. It shows water temperature on normal; It shows setting temperature on setting process; It shows remaining vacation days on vacation mode; It shows unit setting/running parameters, error/protection code on querying. |
| | SET TEMPERATURE | The icon lights up when the water temperature is being set. |
| | | Child lock: If button is locked, the icon will be lightened, otherwise it will be extinguished. |

| | | |
|-----------|-----------------|--|
| 2 Mode | VACATION | VACATION MODE: For the outgoing vacation mode, the water tank is set at 15°C. Maintains low tank water temperature, preheats hot water and anti-freeze lines, while reducing on/off operation of the tank. |
| | HYBRID | HYBRID MODE: Operating in heat pump mode, The unit will determine whether to turn on the e-heater according to the current state(when the water can not reach the set temperature only with heat pump). |
| | E-HEATER | E-HEATER MODE: Operate in accordance with the heat pump mode, the heat pump and the E-heater running at the same time. |
| | ECONOMY | ECONOMY MODE: It is recommended to use this mode of operation whenever possible, as it saves more energy. The heat pump unit heats up to the maximum water temperature before turning on the e-heater for heating, the heat pump and the e-heater will not be turned on at the same time. |
| | SMART | SMART MODE Records the hot water usage habits of users over the past 7 days and turns on the heating in advance according to the user's peak water usage hours. All other unconventional hot water hours are in standby mode, without heating operation (it is recommended that users set this mode after 7 days of regular and normal operation of the water heater to avoid affecting the normal use of the water heater by failing to record the complete user habits.) |

| | | |
|------------|---|---|
| 3 Function |  | It will be lighted when the machine is disinfecting. |
| |  | E-heater: It will be lighted when e-heater is running, otherwise it will be extinguished. NOTE: When the operating conditions are not met to turn on the e-heater, the corresponding icon will briefly light up and then goes off. |
| |  | Heat pump icon: When the heat pump is operating and producing hot water, the icon lights up. |
| |  | EVU: When the photovoltaic effective signal is detected, this icon lights up, this time the target temperature of the machine is adjusted to the highest set temperature, and the machine makes hot water quickly.(some units) |
| |  | Smart Grid ICON: When the SG signal is invalid, this icon does not light up and the machine does not switch on normally.(some units) |
| |  | The icon lights up when the clock is being set. |
| |  | Wireless: <ul style="list-style-type: none">  will be lightened when Wireless is connected;  will be extinguished when Wireless is not connected;  will flash with 2Hz frequency when setting Wireless. |

| | | |
|-----------|---|---|
| 4 Warning |  | When any key is invalid, this icon will flash 3 sec. |
| |  | Error: It will be lightened when unit is under protection/error. |
| |  | It flashes to remind the user to maintain the water tank. If you do not need maintenance reminders, you can enter engineering mode channel 2 to disable this function, or engineering mode 4 to reset the maintenance reminder time, the default maintenance reminder time is 365 days. |
| |  | High temp. alarm If water temp is higher than 50°C, it will be lightened, otherwise it will be extinguished. |
| 5 Timer |  | Time and clock setting It shows the clock. |
| |  | Schedule settings There is an option to set a schedule on weekly or daily basis. If no schedule is set, the appropriate part of the screen remains blank. Otherwise “WEEK” or “DAY” is displayed accordingly. During setting the corresponding icon (“WEEK” or “DAY”) is flashing. |

14.2 Button explanation

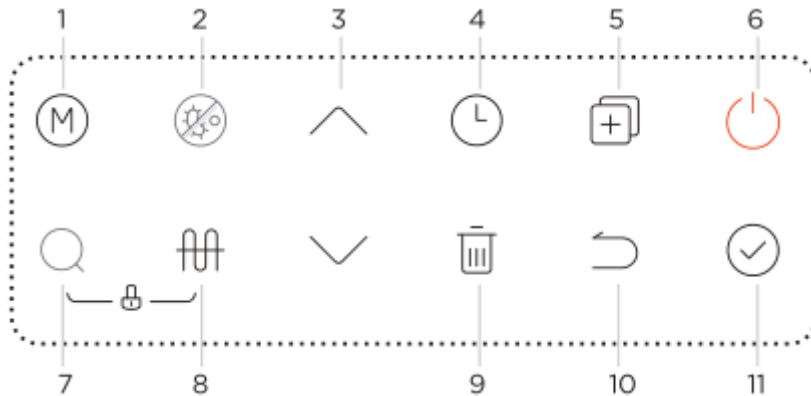



Notes: Any press of button is effective only under button and display unlocked state.

NOTE:





Any pressing of button is effective only under button and display unlocked state. When the operating conditions are not met to turn on this function, the corresponding icon on the wire controller lights up briefly and then goes out.

Basic function

1) Weekly disinfect function

Under disinfection unit immediately start to heat water up to 70°C to kill the potential legionella bacteria inside water of tank,  icon will light on the display screen during disinfection. Unit will quit disinfection if water temperature is higher than 70°C and extinguish  icon.



















2) Vacation function

Press  to select VACATION, then unit will automatically heat water to 15°C for the purpose of energy saving during vacation days. Press   to adjust vacation days and press  to make the setting effective.

3) Remote shutdown function

Users can connect a switch. If the switch is closed, the unit will be stopped forcibly. If switch breaks, the unit can run normally according settings.

| No | Icon | Description |
|----|---|---|
| 1 | | <p>MODE Press this button to switch mode</p> <p>HYBRID ▶ E-HEATER ▶ ECONOMY ▶ SMART ▶ VACATION ▶ VACATION</p> |
| 2 | | Click the button to turn on the forced sterilization function. |
| 3 | | <p>UP & DOWN</p> <p>If screen is unlocked, press ^ v to adjust corresponding value. While setting temperature/timer/vacation days, press more than 1s to change the value continuously. Press ☑ to make the setting effective. On querying, use the buttons to switch check items.</p> |
| 4 | | <p>TIMER Press ⌚ to select daily/weekly timer, and press ☑ to enter the setting interface.</p> <p>Daily timer setting: When setting the daily timer, there is a total of 6 periods, each period has on/off time, mode and water temperature can be set (the default settings: energy saving mode, 60°C).</p> <ul style="list-style-type: none"> Set the target value for current period, and press ☑ to enter the next, or press ⏪ to return previous setting. After all settings for all periods, press ☑ again to |
| | | <p>return to the main screen.</p> <ul style="list-style-type: none"> While setting the [on/off time], you can restore to the default value (displaying-.-) by pressing ⏪. If there is a conflict between two time periods, settings of the later one will be valid, and the earlier one will be canceled and turn back to default values. If you adjust a value again after all the setting is completed, then the settings after the adjustment period will be canceled and turn back to default values. You can enter the timer setting in both power-on and power-off state. <p>Weekly timer setting:</p> <p>Weekly timer has a total of 7 days, press ☑ to enter the setting of the selected day. Then it can be set by the same way as a daily timer.</p> <ul style="list-style-type: none"> To copy the settings of one day to other days: While in the day selection, press ⏪ to copy a base day's settings, then select other days by pressing ⏪ again (the status will become fast flashing). Press ☑ to confirm the operation and the settings will be copied to the selected days. |
| 5 | ENGINEERING MODE only for qualified person | <p>COPY / ENGINEERING MODE</p> <p>In the main screen, press and hold ⏪ for 3 seconds to enter the engineering mode. Use ^ v to switch the inspection channel, and the attribute value of the channel will be displayed. You can modify the parameter setting with ^ v ,and after adjusting, press ☑ to make the setting effective. Press ⏪ to return to the channel selection screen.</p> <p>After 30 seconds from the last operation, or by pressing the return key or the on/off key, you can directly exit the engineering mode.</p> <p>⚠ CAUTION</p> <ul style="list-style-type: none"> It is strictly prohibited for the customer to change the parameter settings of other channels in the engineering mode without authorization to avoid affecting the normal operation of the unit or causing damage to the unit. |

| | | |
|----|--|--|
| 6 |  | POWER ON/OFF Press the button to start / stop the unit. |
| 7 |  | SEARCH / QUERY MODE <ul style="list-style-type: none"> In the main screen, press and hold  for 1 second to enter the query mode. Use   to switch the spot check channel, and the attribute value of the channel will be displayed, please refer to the following table for details. After 30 seconds from the last operation, or by pressing  or  , you can directly exit the query mode. Query mode can be entered in both power-on and power-off state. |
| 8 |  | If screen is unlocked, press this button to manually activate E-HEATER. |
| 9 |  | DELETE This key is used to cancel all settings and exit the setting state. When the wireless connection is working, long press  for more than 8s to exit Wireless connection. |
| 10 |  | RETURN Press the button to return to the previous setting or main screen. |
| 11 |  | CONFIRM If screen and buttons are unlocked, press it to upload setting parameters after setting any parameter. |
| 12 |  | CHILD LOCK <ul style="list-style-type: none"> In the main screen, long press the key combination for 2 seconds to enter the child lock state; In the state of child lock, long press the key combination again for 2 seconds to release the child lock state; In the locked state, there will be an icon  next to the water temperature display. |
| 13 |  Press for 3 sec | Connecting the wireless function <ul style="list-style-type: none"> In the main interface, long press  for 3 seconds to enter the AP wireless network mode, there will be a  in the upper right corner of the line controller. At this time, enter the APP, select the category of air water heater, choose the correct model, and then network according to the APP prompts, and after the network is completed, the wireless icon  will be always on; Wireless matching can last up to 8 minutes, after 8 minutes, if the matching is not successful, the wireless icon will go out; Long press  for 8 seconds in the main interface to reset the wireless function; It can be set in both power on and power off state. |

Use Your Appliance with the MSmartHome App

Ensure that your mobile phone is connected to the home wireless network, the 2.4GHz band wireless signal is enabled on your wireless router and you know the network password.

Turn on Bluetooth on your phone and the device must also be powered up.

Step 1: Download the Smart Home app

Scan the QR code below to download the Smart Home app from app store or search for it directly on the Google Play Store or Apple's App Store.

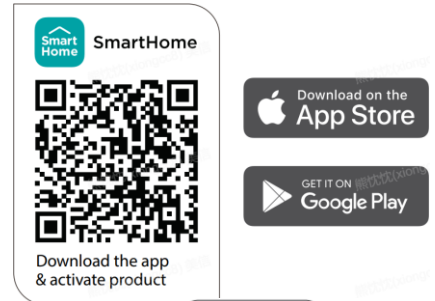

Step 2: Log in

Open the Smart Home app. Log in directly if you have an existing Smart Home account or create a new account. Alternatively, you can also use a 3rd party login platform.



Step 3: Connecting the device

- 1) When you log in, you may see the message "Smart devices discovered nearby". Tap to add your device.
- 2) If no such message appears, proceed as follows: Tap on "+" and select your device in the list of nearby available devices.

If your device is not listed, please add your device manually, first selecting the device category e.g. Water Heater.

- 3) Follow the steps in the app to connect your device to the wireless network. If your device fails to connect, follow the additional instructions in the app.

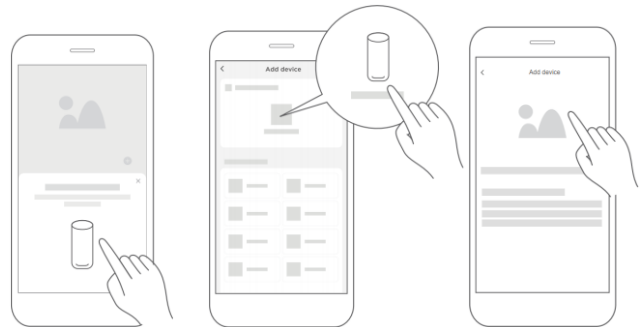

Step 4: Controlling the device

After pairing successfully, a card will be created for the device in the Smart Home app.

Shortcuts for basic functions will appear on the card such as changing the humidity or switching the device on or off.

Tapping on the card, will reveal additional features and settings. The actual UI design may look different from examples due to app updates

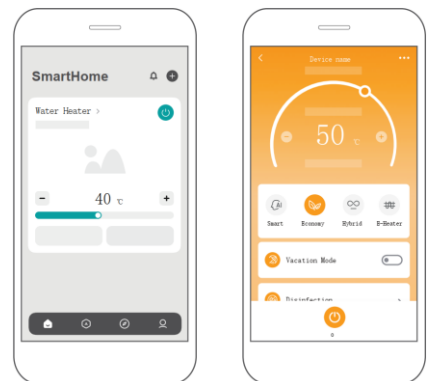

14. Accessories

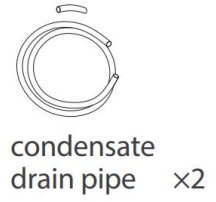
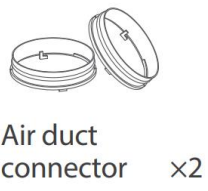
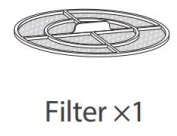
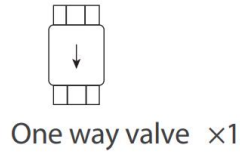
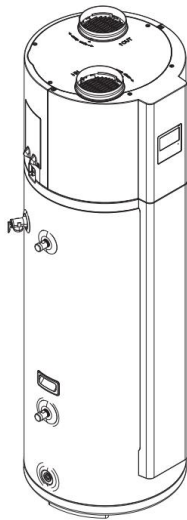

| Name | Qty. |
|-----------------------|------|
| Main unit | 1 |
| One way valve | 1 |
| Air duct connector | 2 |
| Fixing strip | 1 |
| Filter | 1 |
| Condensate drain pipe | 2 |
| Safety manual | 1 |
| User's manual | 1 |

15. Resistance characteristic of temperature sensor

➤ Resistance characteristic of ambient Temp., pipe Temp. and suction Temp. sensor.

| Temp. (°C) | Resistance value (kΩ) | Temp. (°C) | Resistance value (kΩ) | Temp. (°C) | Resistance value (kΩ) | Temp. (°C) | Resistance value (kΩ) |
|------------|-----------------------|------------|-----------------------|------------|-----------------------|------------|-----------------------|
| -20 | 115.266 | 20 | 12.6431 | 60 | 2.35774 | 100 | 0.62973 |
| -19 | 108.146 | 21 | 12.0561 | 61 | 2.27249 | 101 | 0.61148 |
| -18 | 101.517 | 22 | 11.5 | 62 | 2.19073 | 102 | 0.59386 |
| -17 | 96.3423 | 23 | 10.9731 | 63 | 2.11241 | 103 | 0.57683 |
| -16 | 89.5865 | 24 | 10.4736 | 64 | 2.03732 | 104 | 0.56038 |
| -15 | 84.219 | 25 | 10 | 65 | 1.96532 | 105 | 0.54448 |
| -14 | 79.311 | 26 | 9.55074 | 66 | 1.89627 | 106 | 0.52912 |
| -13 | 74.536 | 27 | 9.12445 | 67 | 1.83003 | 107 | 0.51426 |
| -12 | 70.1698 | 28 | 8.71983 | 68 | 1.76647 | 108 | 0.49989 |
| -11 | 66.0898 | 29 | 8.33566 | 69 | 1.70547 | 109 | 0.486 |
| -10 | 62.2756 | 30 | 7.97078 | 70 | 1.64691 | 110 | 0.47256 |
| -9 | 58.7079 | 31 | 7.62411 | 71 | 1.59068 | 111 | 0.45957 |
| -8 | 56.3694 | 32 | 7.29464 | 72 | 1.53668 | 112 | 0.44699 |
| -7 | 52.2438 | 33 | 6.98142 | 73 | 1.48481 | 113 | 0.43482 |
| -6 | 49.3161 | 34 | 6.68355 | 74 | 1.43498 | 114 | 0.42304 |
| -5 | 46.5725 | 35 | 6.40021 | 75 | 1.38703 | 115 | 0.41164 |
| -4 | 44 | 36 | 6.13059 | 76 | 1.34105 | 116 | 0.4006 |
| -3 | 41.5878 | 37 | 5.87359 | 77 | 1.29078 | 117 | 0.38991 |
| -2 | 39.8239 | 38 | 5.62961 | 78 | 1.25423 | 118 | 0.37956 |
| -1 | 37.1988 | 39 | 5.39689 | 79 | 1.2133 | 119 | 0.36954 |
| 0 | 35.2024 | 40 | 5.17519 | 80 | 1.17393 | 120 | 0.35982 |
| 1 | 33.3269 | 41 | 4.96392 | 81 | 1.13604 | 121 | 0.35042 |
| 2 | 31.5635 | 42 | 4.76253 | 82 | 1.09958 | 122 | 0.3413 |
| 3 | 29.9058 | 43 | 4.5705 | 83 | 1.06448 | 123 | 0.33246 |
| 4 | 28.3459 | 44 | 4.38736 | 84 | 1.03069 | 124 | 0.3239 |
| 5 | 26.8778 | 45 | 4.21263 | 85 | 0.99815 | 125 | 0.31559 |
| 6 | 25.4954 | 46 | 4.04589 | 86 | 0.96681 | 126 | 0.30754 |
| 7 | 24.1932 | 47 | 3.88673 | 87 | 0.93662 | 127 | 0.29974 |
| 8 | 22.5662 | 48 | 3.73476 | 88 | 0.90753 | 128 | 0.29216 |
| 9 | 21.8094 | 49 | 3.58962 | 89 | 0.8795 | 129 | 0.28482 |
| 10 | 20.7184 | 50 | 3.45097 | 90 | 0.85248 | 130 | 0.2777 |
| 11 | 19.6891 | 51 | 3.31847 | 91 | 0.82643 | 131 | 0.27078 |
| 12 | 18.7177 | 52 | 3.19183 | 92 | 0.80132 | 132 | 0.26408 |
| 13 | 17.8005 | 53 | 3.07075 | 93 | 0.77709 | 133 | 0.25757 |
| 14 | 16.9341 | 54 | 2.95896 | 94 | 0.75373 | 134 | 0.25125 |
| 15 | 16.1156 | 55 | 2.84421 | 95 | 0.73119 | 135 | 0.24512 |
| 16 | 15.3418 | 56 | 2.73823 | 96 | 0.70944 | 136 | 0.23916 |
| 17 | 14.6181 | 57 | 2.63682 | 97 | 0.68844 | 137 | 0.23338 |
| 18 | 13.918 | 58 | 2.53973 | 98 | 0.66818 | 138 | 0.22776 |
| 19 | 13.2631 | 59 | 2.44677 | 99 | 0.64862 | 139 | 0.22231 |

➤ Resistance characteristic of discharge temperature sensor

| Temp. (°C) | Resistance value (kΩ) | Temp. (°C) | Resistance value (kΩ) | Temp. (°C) | Resistance value (kΩ) | Temp. (°C) | Resistance value (kΩ) |
|------------|-----------------------|------------|-----------------------|------------|-----------------------|-----------------|-----------------------|
| -20 | 542.7 | 20 | 68.66 | 60 | 13.59 | 100 | 3.702 |
| -19 | 511.9 | 21 | 65.62 | 61 | 13.11 | 101 | 3.595 |
| -18 | 483 | 22 | 62.73 | 62 | 12.65 | 102 | 3.492 |
| -17 | 455.9 | 23 | 59.98 | 63 | 12.21 | 103 | 3.392 |
| -16 | 430.5 | 24 | 57.37 | 64 | 11.79 | 104 | 3.296 |
| -15 | 406.7 | 25 | 54.89 | 65 | 11.38 | 105 | 3.203 |
| -14 | 384.3 | 26 | 52.53 | 66 | 10.99 | 106 | 3.113 |
| -13 | 363.3 | 27 | 50.28 | 67 | 10.61 | 107 | 3.025 |
| -12 | 343.6 | 28 | 48.14 | 68 | 10.25 | 108 | 2.941 |
| -11 | 325.1 | 29 | 46.11 | 69 | 9.902 | 109 | 2.86 |
| -10 | 307.7 | 30 | 44.17 | 70 | 9.569 | 110 | 2.781 |
| -9 | 291.3 | 31 | 42.33 | 71 | 9.248 | 111 | 2.704 |
| -8 | 275.9 | 32 | 40.57 | 72 | 8.94 | 112 | 2.63 |
| -7 | 261.4 | 33 | 38.89 | 73 | 8.643 | 113 | 2.559 |
| -6 | 247.8 | 34 | 37.3 | 74 | 8.358 | 114 | 2.489 |
| -5 | 234.9 | 35 | 35.78 | 75 | 8.084 | 115 | 2.422 |
| -4 | 222.8 | 36 | 34.32 | 76 | 7.82 | 116 | 2.357 |
| -3 | 211.4 | 37 | 32.94 | 77 | 7.566 | 117 | 2.294 |
| -2 | 200.7 | 38 | 31.62 | 78 | 7.321 | 118 | 2.233 |
| -1 | 190.5 | 39 | 30.36 | 79 | 7.086 | 119 | 2.174 |
| 0 | 180.9 | 40 | 29.15 | 80 | 6.859 | 120 | 2.117 |
| 1 | 171.9 | 41 | 28 | 81 | 6.641 | 121 | 2.061 |
| 2 | 163.3 | 42 | 26.9 | 82 | 6.43 | 122 | 2.007 |
| 3 | 155.2 | 43 | 25.86 | 83 | 6.228 | 123 | 1.955 |
| 4 | 147.6 | 44 | 24.85 | 84 | 6.033 | 124 | 1.905 |
| 5 | 140.4 | 45 | 23.89 | 85 | 5.844 | 125 | 1.856 |
| 6 | 133.5 | 46 | 22.89 | 86 | 5.663 | 126 | 1.808 |
| 7 | 127.1 | 47 | 22.1 | 87 | 5.488 | 127 | 1.762 |
| 8 | 121 | 48 | 21.26 | 88 | 5.32 | 128 | 1.717 |
| 9 | 115.2 | 49 | 20.46 | 89 | 5.157 | 129 | 1.674 |
| 10 | 109.8 | 50 | 19.69 | 90 | 5 | 130 | 1.632 |
| 11 | 104.6 | 51 | 18.96 | 91 | 4.849 | | |
| 12 | 99.69 | 52 | 18.26 | 92 | 4.703 | | |
| 13 | 95.05 | 53 | 17.58 | 93 | 4.562 | | |
| 14 | 90.66 | 54 | 16.94 | 94 | 4.426 | | |
| 15 | 86.49 | 55 | 16.32 | 95 | 4.294 | B(25/50)=3950K | |
| 16 | 82.54 | 56 | 15.73 | 96 | 4.167 | | |
| 17 | 78.79 | 57 | 15.16 | 97 | 4.045 | R(90°C)=5KΩ+-3% | |
| 18 | 75.24 | 58 | 14.62 | 98 | 3.927 | | |
| 19 | 71.86 | 59 | 14.09 | 99 | 3.812 | | |

➤ Resistance characteristic of water tank temperature sensor & solar temperature sensor

| Temp. (°C) | Max. Resistance value (kΩ) | Normal Resistance value (kΩ) | Min. Resistance value (kΩ) | Temp. Tol. (°C) | |
|------------|----------------------------|------------------------------|----------------------------|-----------------|------|
| -30 | 965.72 | 867.29 | 778.18 | -1.78 | 1.73 |
| -29 | 907.28 | 815.80 | 732.88 | -1.78 | 1.72 |
| -28 | 852.73 | 767.68 | 690.49 | -1.77 | 1.72 |
| -27 | 801.77 | 722.68 | 650.80 | -1.76 | 1.71 |
| -26 | 754.12 | 680.54 | 613.59 | -1.75 | 1.70 |
| -25 | 709.53 | 641.07 | 578.70 | -1.73 | 1.69 |
| -24 | 667.79 | 604.08 | 545.95 | -1.72 | 1.68 |
| -23 | 628.70 | 569.39 | 515.21 | -1.71 | 1.67 |
| -22 | 592.07 | 536.85 | 486.34 | -1.70 | 1.65 |
| -21 | 557.76 | 506.33 | 459.22 | -1.68 | 1.64 |
| -20 | 525.60 | 477.69 | 433.75 | -1.67 | 1.63 |
| -19 | 495.45 | 450.81 | 409.82 | -1.66 | 1.63 |
| -18 | 467.19 | 425.59 | 387.34 | -1.65 | 1.62 |
| -17 | 440.70 | 401.91 | 366.21 | -1.64 | 1.61 |
| -16 | 415.86 | 379.69 | 346.36 | -1.63 | 1.60 |
| -15 | 392.57 | 358.83 | 327.70 | -1.62 | 1.59 |
| -14 | 370.72 | 339.24 | 310.16 | -1.61 | 1.58 |
| -13 | 350.23 | 320.85 | 293.66 | -1.60 | 1.57 |
| -12 | 331.00 | 303.56 | 278.16 | -1.59 | 1.56 |
| -11 | 312.95 | 287.33 | 263.57 | -1.58 | 1.56 |
| -10 | 296.00 | 272.06 | 249.84 | -1.57 | 1.55 |
| -9 | 280.08 | 257.71 | 236.92 | -1.56 | 1.54 |
| -8 | 265.12 | 244.21 | 224.75 | -1.55 | 1.53 |
| -7 | 251.06 | 231.51 | 213.28 | -1.54 | 1.52 |
| -6 | 237.84 | 219.55 | 202.48 | -1.53 | 1.52 |
| -5 | 225.40 | 208.28 | 192.29 | -1.52 | 1.51 |
| -4 | 213.69 | 197.67 | 182.69 | -1.51 | 1.50 |
| -3 | 202.66 | 187.66 | 173.62 | -1.50 | 1.49 |
| -2 | 192.27 | 178.22 | 165.05 | -1.49 | 1.48 |
| -1 | 182.47 | 168.31 | 156.96 | -1.48 | 1.47 |
| 0 | 173.23 | 160.90 | 149.32 | -1.47 | 1.46 |
| 1 | 164.51 | 152.96 | 142.09 | -1.45 | 1.45 |
| 2 | 156.28 | 145.45 | 135.25 | -1.44 | 1.44 |
| 3 | 148.50 | 138.35 | 128.78 | -1.43 | 1.43 |
| 4 | 141.15 | 131.64 | 122.65 | -1.42 | 1.41 |
| 5 | 134.21 | 125.28 | 116.85 | -1.40 | 1.40 |
| 6 | 127.64 | 119.27 | 111.35 | -1.39 | 1.39 |
| 7 | 121.43 | 113.58 | 106.14 | -1.38 | 1.38 |
| 8 | 115.55 | 108.18 | 101.19 | -1.37 | 1.37 |
| 9 | 109.98 | 103.07 | 96.507 | -1.35 | 1.36 |

| Temp. (°C) | Max. Resistance value (kΩ) | Normal Resistance value (kΩ) | Min. Resistance value (kΩ) | Temp. Tol. (°C) | |
|------------|----------------------------|------------------------------|----------------------------|-----------------|------|
| 10 | 104.71 | 98.227 | 92.060 | -1.34 | 1.34 |
| 11 | 99.722 | 93.634 | 87.839 | -1.33 | 1.33 |
| 12 | 94.992 | 89.278 | 83.832 | -1.31 | 1.32 |
| 13 | 90.510 | 85.146 | 80.028 | -1.30 | 1.31 |
| 14 | 86.261 | 81.225 | 76.415 | -1.28 | 1.29 |
| 15 | 82.232 | 77.504 | 72.983 | -1.27 | 1.28 |
| 16 | 78.411 | 73.972 | 69.722 | -1.26 | 1.27 |
| 17 | 74.787 | 70.619 | 66.623 | -1.24 | 1.25 |
| 18 | 71.348 | 67.434 | 63.677 | -1.23 | 1.24 |
| 19 | 68.085 | 64.409 | 60.876 | -1.22 | 1.23 |
| 20 | 64.988 | 61.535 | 58.213 | -1.20 | 1.22 |
| 21 | 62.047 | 58.804 | 55.680 | -1.19 | 1.20 |
| 22 | 59.255 | 56.209 | 53.271 | -1.17 | 1.19 |
| 23 | 56.604 | 53.742 | 50.978 | -1.16 | 1.18 |
| 24 | 54.085 | 51.396 | 48.797 | -1.15 | 1.17 |
| 25 | 51.691 | 49.165 | 46.720 | -1.13 | 1.15 |
| 26 | 49.417 | 47.043 | 44.744 | -1.12 | 1.14 |
| 27 | 47.255 | 45.025 | 42.861 | -1.10 | 1.13 |
| 28 | 45.199 | 43.104 | 41.068 | -1.09 | 1.11 |
| 29 | 43.245 | 41.276 | 39.361 | -1.08 | 1.10 |
| 30 | 41.386 | 39.535 | 37.733 | -1.06 | 1.09 |
| 31 | 39.617 | 37.878 | 36.183 | -1.05 | 1.07 |
| 32 | 37.934 | 36.299 | 34.704 | -1.04 | 1.06 |
| 33 | 36.331 | 34.796 | 33.295 | -1.02 | 1.05 |
| 34 | 34.806 | 33.363 | 31.951 | -1.01 | 1.03 |
| 35 | 33.353 | 31.977 | 30.668 | -0.99 | 1.02 |
| 36 | 31.970 | 30.695 | 29.445 | -0.98 | 1.01 |
| 37 | 30.651 | 29.453 | 28.277 | -0.96 | 0.99 |
| 38 | 29.394 | 28.269 | 27.162 | -0.95 | 0.98 |
| 39 | 28.196 | 27.139 | 26.098 | -0.94 | 0.97 |
| 40 | 27.054 | 26.061 | 25.081 | -0.92 | 0.95 |
| 41 | 25.964 | 25.031 | 24.110 | -0.91 | 0.94 |
| 42 | 24.925 | 24.048 | 23.182 | -0.89 | 0.92 |
| 43 | 23.933 | 23.109 | 22.294 | -0.88 | 0.91 |
| 44 | 22.986 | 22.212 | 21.446 | -0.86 | 0.89 |
| 45 | 22.081 | 21.355 | 20.635 | -0.85 | 0.88 |
| 46 | 21.217 | 20.536 | 19.858 | -0.83 | 0.86 |
| 47 | 20.392 | 19.752 | 19.116 | -0.82 | 0.85 |
| 48 | 19.603 | 19.003 | 18.405 | -0.80 | 0.83 |
| 49 | 18.849 | 18.286 | 17.724 | -0.79 | 0.82 |

| Temp. (°C) | Max. Resistance value (kΩ) | Normal Resistance value (kΩ) | Min. Resistance value (kΩ) | Temp. Tol. (°C) | |
|------------|----------------------------|------------------------------|----------------------------|-----------------|------|
| 50 | 18.128 | 17.600 | 17.072 | -0.77 | 0.80 |
| 51 | 17.465 | 16.943 | 16.423 | -0.79 | 0.83 |
| 52 | 16.830 | 16.315 | 15.801 | -0.82 | 0.85 |
| 53 | 16.221 | 15.713 | 15.207 | -0.84 | 0.88 |
| 54 | 15.637 | 15.136 | 14.638 | -0.87 | 0.90 |
| 55 | 15.077 | 14.583 | 14.093 | -0.89 | 0.93 |
| 56 | 14.541 | 14.054 | 13.571 | -0.92 | 0.95 |
| 57 | 14.026 | 13.546 | 13.071 | -0.94 | 0.98 |
| 58 | 13.531 | 13.059 | 12.592 | -0.97 | 1.00 |
| 59 | 13.057 | 12.592 | 12.133 | -1.00 | 1.03 |
| 60 | 12.602 | 12.144 | 11.693 | -1.02 | 1.05 |
| 61 | 12.165 | 11.715 | 11.271 | -1.05 | 1.08 |
| 62 | 11.745 | 11.302 | 10.866 | -1.07 | 1.10 |
| 63 | 11.342 | 10.906 | 10.478 | -1.10 | 1.13 |
| 64 | 10.954 | 10.526 | 10.106 | -1.13 | 1.15 |
| 65 | 10.582 | 10.161 | 9.7486 | -1.15 | 1.18 |
| 66 | 10.224 | 9.8105 | 9.4056 | -1.18 | 1.20 |
| 67 | 9.8794 | 9.4736 | 9.0762 | -1.20 | 1.23 |
| 68 | 9.5484 | 9.1498 | 8.7600 | -1.23 | 1.25 |
| 69 | 9.2301 | 8.8387 | 8.4562 | -1.26 | 1.28 |
| 70 | 8.9239 | 8.5396 | 8.1645 | -1.28 | 1.30 |
| 71 | 8.6293 | 8.2520 | 7.8841 | -1.31 | 1.33 |
| 72 | 8.3458 | 7.9755 | 7.6147 | -1.34 | 1.36 |
| 73 | 8.0729 | 7.7094 | 7.3557 | -1.37 | 1.38 |
| 74 | 7.8102 | 7.4536 | 7.1068 | -1.39 | 1.41 |
| 75 | 7.5573 | 7.2073 | 6.8674 | -1.42 | 1.43 |
| 76 | 7.3137 | 6.9704 | 6.6372 | -1.45 | 1.46 |
| 77 | 7.0791 | 6.7423 | 6.4157 | -1.48 | 1.49 |
| 78 | 6.8532 | 6.5228 | 6.2027 | -1.50 | 1.51 |
| 79 | 6.6354 | 6.3114 | 5.9977 | -1.53 | 1.54 |
| 80 | 6.4256 | 6.1078 | 5.8005 | -1.56 | 1.57 |
| 81 | 6.2234 | 5.9117 | 5.6106 | -1.59 | 1.59 |
| 82 | 6.0285 | 5.7228 | 5.4278 | -1.62 | 1.62 |
| 83 | 5.8405 | 5.5409 | 5.2518 | -1.65 | 1.65 |
| 84 | 5.6593 | 5.3655 | 5.0823 | -1.68 | 1.68 |
| 85 | 5.4846 | 5.1965 | 4.9191 | -1.70 | 1.70 |
| 86 | 5.3160 | 5.0336 | 4.7618 | -1.73 | 1.73 |
| 87 | 5.1534 | 4.8765 | 4.6103 | -1.76 | 1.76 |
| 88 | 4.9965 | 4.7251 | 4.4643 | -1.79 | 1.79 |
| 89 | 4.8451 | 4.5790 | 4.3236 | -1.82 | 1.81 |

| Temp. (°C) | Max. Resistance value (kΩ) | Normal Resistance value (kΩ) | Min. Resistance value (kΩ) | Temp. Tol. (°C) | |
|--------------------|----------------------------|------------------------------|----------------------------|-----------------|------|
| 90 | 4.6990 | 4.4381 | 4.1880 | -1.85 | 1.84 |
| 91 | 4.5579 | 4.3022 | 4.0572 | -1.88 | 1.87 |
| 92 | 4.4218 | 4.1711 | 3.9312 | -1.91 | 1.90 |
| 93 | 4.2903 | 4.0446 | 3.8096 | -1.94 | 1.92 |
| 94 | 4.1633 | 3.9225 | 3.6923 | -1.97 | 1.95 |
| 95 | 4.0407 | 3.8046 | 3.5791 | -2.00 | 1.98 |
| 96 | 3.9222 | 3.6908 | 3.4700 | -2.03 | 2.01 |
| 97 | 3.8077 | 3.5810 | 3.3647 | -2.06 | 2.04 |
| 98 | 3.6971 | 3.4748 | 3.2630 | -2.09 | 2.07 |
| 99 | 3.5902 | 3.3724 | 3.1649 | -2.13 | 2.10 |
| 100 | 3.4869 | 3.2734 | 3.0701 | -2.16 | 2.12 |
| 101 | 3.3870 | 3.1777 | 2.9786 | -2.19 | 2.15 |
| 102 | 3.2905 | 3.0853 | 2.8903 | -2.22 | 2.18 |
| 103 | 3.1971 | 2.9960 | 2.8050 | -2.25 | 2.21 |
| 104 | 3.1068 | 2.9096 | 2.7226 | -2.28 | 2.24 |
| 105 | 3.0194 | 2.8262 | 2.6429 | -2.32 | 2.27 |
| R50=17.6KΩ ± 3% | | | | | |
| B0/100=3,970K ± 2% | | | | | |

NOTE CONCERNING PROTECTION OF ENVIRONMENT

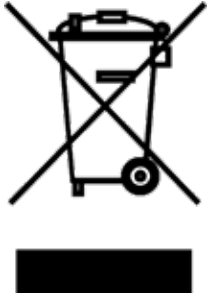

This product must not be disposed of via normal household waste after its service life, but must be taken to a collection station for the recycling of electrical and electronic devices. The symbol on the product, the operating instructions or the packaging indicate such disposal procedures. The materials are recyclable in accordance with their respective symbols. By means of re-use, material recycling or any other form of recycling old appliances you are making an important contribution to the protection of our environment. Please ask your local council where your nearest disposal station is located.

INFORMATION CONCERNING USED REFRIGERANT MEDIUM

This unit is containing fluorinated gases included in the Kyoto protocol.
The maintenance and the liquidation must be carried out by qualified personnel.

Type of refrigerant: R290

The quantity of the refrigerant: Please see the unit label.

The value GWP: 3 (1 kg R290 = 0,003 t CO₂ eq)

GWP = Global Warming Potential



Appliance filled with flammable gas R290.

In case of quality problem or other please contact your local supplier or authorized service center.

Emergency number: 112

PRODUCER

SINCLAIR CORPORATION Ltd.
16 Great Queen Street
WC2B 5AH London
United Kingdom
www.sinclair-world.com

This product was manufactured in China (Made in China).

REPRESENTATIVE

SINCLAIR Global Group s.r.o.
Purkynova 45
612 00 Brno
Czech Republic

TECHNICAL SUPPORT

SINCLAIR Global Group s.r.o.
Purkynova 45
612 00 Brno
Czech Republic
Tel.: +420 800 100 285 | Fax: +420 541 590 124
www.sinclair-solutions.com | info@sinclair-solutions.com



